



# TOWN OF DILLON DESIGN GUIDELINES

March 2017



## ACKNOWLEDGMENTS

---

### SPECIAL THANKS

Special thanks to the Town of Dillon Economic Development Advisory Committee (EDAC), Planning and Zoning Committee (P&Z), and the Town Council for their input towards the development of these Design Guidelines.

### GUIDELINES PREPARED FOR:



The Town of Dillon

### GUIDELINES PREPARED BY:



Roth Sheppard Architects



# TABLE OF CONTENTS

---

1	INTRODUCTION	1
	Purpose and Intent	2
	Application	2
	Zoning Map	3
	Aesthetic Position	4
	Additional Graphic Submittal Materials	5
	Document Organization	5
	Essential Terms	6
2	CHARACTER & ENVIRONMENT:	8
	CE1 Draw Authenticity from Historic Architecture	9
	CE2 Define the Public Domain	11
	CE3 Create Complementary Developments	17
	CE4 Take Advantage of the Climate	18
	CE Design Standards Checklist	19
3	BUILDING FORM & ARTICULATION:	20
	BFA1 Express the Base, Middle, & Top	21
	BFA2 Express the Building Weight & Structure	24
	BFA3 Building Heights & View Corridors	26
	BFA4 Express the Roof Form	27
	BFA5 Create Recesses & Projections	31
	BFA Design Standards Checklist	32
4	CRAFT, MATERIALS, & COLORS:	33
	CMC1 Highlight the Craft	34
	CMC2 Use Local Materials & Textures	36
	CMC3 Color Palettes and Accents	41
	CMC Design Standards Checklist	42

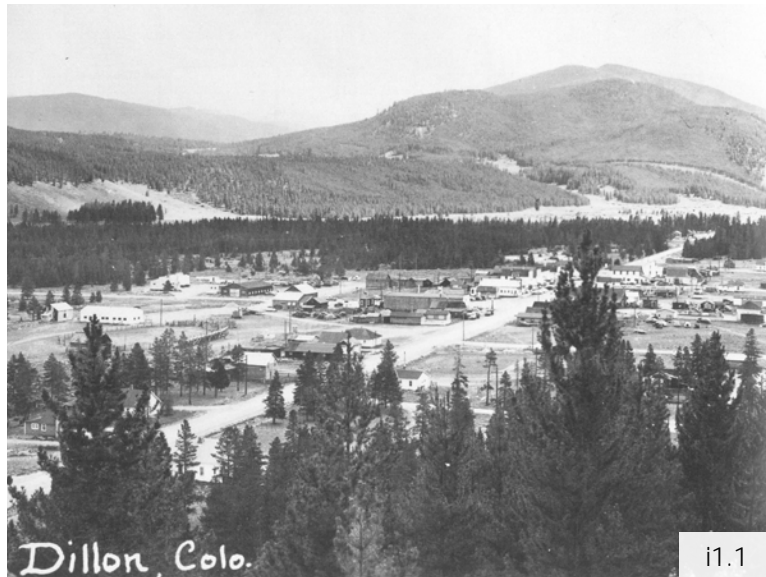

A vintage photograph of old Dillon taken prior to 1960; Dillon was a trading post, stage stop, and train route before it was mostly demolished and uprooted by Denver Water to make room for the Lake Dillon Reservoir.

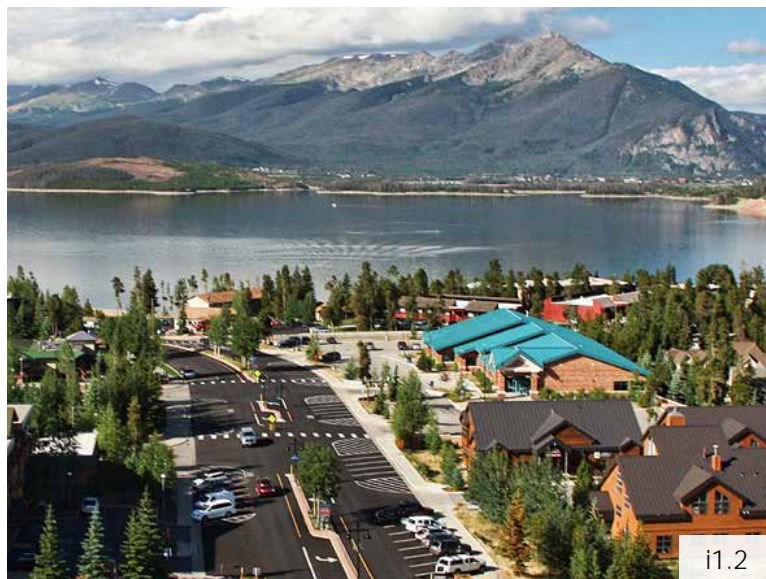

Photograph of Dillon today; an authentic mountain town defined by its majestic lake and the surrounding mountain environment.



# 1 INTRODUCTION

These Design Guidelines were established in an effort to create a cohesive architectural character for future developments within the Town of Dillon. They are intended to clearly illustrate design principles and design standards to both project applicants and the Town of Dillon staff reviewers.

Communities need Design Guidelines (Guidelines) in order to develop in a unified and cohesive manner. All new and remodeled projects in the Town of Dillon should incorporate the principles and standards established in these Guidelines. When utilized and interpreted properly, this document will provide a basis for generating, as well as evaluating, design.

These Guidelines are a product of research and collaboration with the Town of Dillon and its community through monthly meetings held at the La Riva Del Lago and City Hall buildings from October 2016 to January 2017.

Initially, the design team reviewed the existing Zoning Code, Master Plans, and the recently developed marketing Brand Platform document with the Town staff in order to determine the desired visual character for the town of Dillon. The group agreed that the overarching goal for these Guidelines was for Dillon to embrace its unique culture and geography through the look and feel of a Mountain Lakestyle architectural character.

A following meeting with the Town established the critical words and phrases that would become foundational to the development of the architectural patterns that defined the Mountain Lakestyle character in terms of its architectural application. The initial development of these patterns were presented to Town staff and the community for their comments.

The final meeting with the Town Council was conducted to present the refined design principles and standards, and to present conceptual architectural sketches to showcase how these patterns could be applied to the existing Town buildings. Comments from the Town Council were received and incorporated into the Final Draft of these Design Guidelines.



## PURPOSE & INTENT

---

The purpose of these Design Guidelines (Guidelines) for the Town of Dillon is to provide a clear and comprehensive document that articulates the expected quality of development. These Guidelines are intended to be used by both project applicants and the Town of Dillon staff reviewers to ensure the achievement of the community's desired visual character.

These Guidelines were developed through a four month collaboration with the Town of Dillon's Economic Development Advisory Committee (EDAC), Planning and Zoning Committee (P&Z), Town Council, and community.

The intent of these Guidelines is to be a detailed, yet flexible document with visual examples that communicate general design principles to convey aesthetics combined with clear design standards that are required to be met to achieve compliance.

## APPLICATION

---

These Guidelines apply to all developments , remodels, additions, and renovations within the Town. Adherence to these Guidelines will be a component of the development application review process administered by the Town of Dillon. Applicants should review these Guidelines prior to initiating their design and development process, and coordinate their approach with the Town of Dillon Planning and Zoning staff early in the project.



# ZONING MAP

Exhibit 3: Town Zoning Map

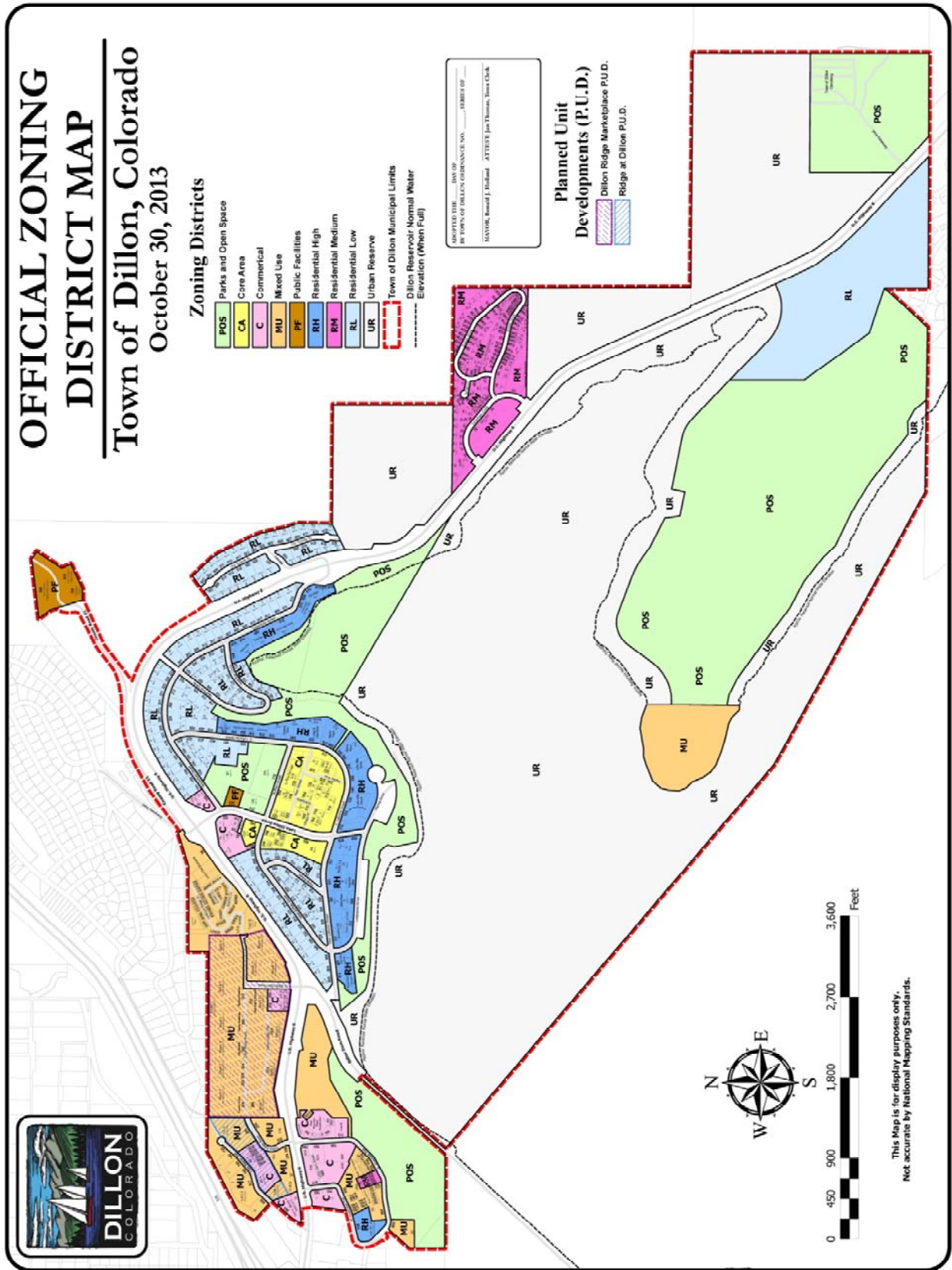



## AESTHETIC POSITION

### MOUNTAIN LAKESTYLE



i1.3

The architectural character of Dillon should represent a Mountain Lakestyle aesthetic. Mountain Lakestyle is the synthesis of architectural principles and patterns from both mountain and lake architecture to create an authentic and unique character that can only be from Dillon, Colorado.

#### Mountain Lakestyle Architectural Principles

Connectivity with the ground

Expression of the public domain

Use of simple and dynamic roof forms with  
exposed structure and support systems

Expression of the building structure

Use of vertical openings and deep  
overhanging roofs and awnings

Use of natural materials and color accents

Transparency and layering

Craft and detail

Simple and pragmatic beauty as an  
expression of functional honesty





## ADDITIONAL GRAPHIC SUBMITTAL MATERIALS

---

The following additional submission materials are required as part of the Town of Dillon - Development Application Process:

### 01 Design Narrative

Individual projects must present a written Design Narrative as part of their development proposal to the Town of Dillon. Within the narrative, applicants should clearly describe how their design enhances the surrounding context, and how their design meets or exceeds the Design Standards checklists. Completed Design Standards checklists should be included with the applicant's Graphic Submittal.

### 02 Design Concept Precedents

Building designs should result from an understanding and interpretation of historic, contemporary, sustainable, and appropriate examples, or precedents, that ultimately lead to form a design concept. Design precedent analysis and conceptual ideas should also be illustrated in the Design Narrative.

### 03 Drawings (In addition to the applicant's required Development Application Process documents)

- 1-2 street level Perspective Renderings (include sufficient context to communicate scale and relationships to surrounding conditions and buildings)
- Graphic Building Elevations (1/8" scale, min. with colors and material indications)
- Roof Snow Melt Runoff and Sidewalk Ice Removal Management Plan (1/8" scale, min.)

### 04 Materials

- Exterior Materials Board w/ labels that correlate with the material labels on the Graphic Building Elev's (4"x4" min/each sample, physical samples are preferred)

## DOCUMENT ORGANIZATION

---

These Guidelines are organized into four Categories: 1. Introduction 2. Character & Environment, 3. Building Form & Articulation, and 4. Craft, Materials, & Colors. These categories are further divided into Sections of architectural patterns and principles. Each Section contains an '**Objective:**' that clearly defines the intent of the Section, and is supported by images and text that provides architectural application to achieve the '**Objective:**'.

**Emboldened text are Design Standards and are required for design compliance. A Design Standards checklist is provided at the end of each category and shall be incorporated into the Design Narrative.**

Underlined text are Essential Terms that define the pattern language used to describe the architectural concepts.

(Text within parentheses and captured by 'single quotation marks' reference other sections that are relevant to that particular topic.)



## ESSENTIAL TERMS

---

360 Degree Architecture	Architecture that addresses the whole building perimeter through the design of each façade.
Apparent Weight	The visual interpretation of the loads or weight of the elements above, as they travel through the building.
Coherent Whole	The ability to understand the collective character and urban design of a grouping of buildings that share common patterns and principles.
Design Standards	Architectural principles that are required to achieve compliance with the design intent of these Guidelines.
Design Guidelines	A manual of design patterns, principles, and standards to create a cohesive architectural character for future developments within a town.
Datum Line	An imaginary line or point of reference that is used to align elements across a building façade, or from one building to another. A fundamental feature of the public domain (the 2-story <u>datum</u> line).
Gable Roof	A roof form with pitches that intersect at the mid-point of the roof mass.
Human-Scale	The physical features of a building that have been scaled to relate to the proportions and movements of humans.
Jewel Building / Site	An approved (by Dillon P&Z) iconic building or site, whose location and use is defined as a contributor to the Civic well-being of the Town of Dillon (i.e. museums, libraries, government buildings, fire and police stations, parks, gardens, squares, etc.)
Economy of Means	The careful management of available resources.



## ESSENTIAL TERMS (CONTINUED)

---

Mountain Lakestyle	The combination of mountain and lake features to create an authentic and unique architecture that can only be from Dillon, Colorado.
Pragmatic (Design)	The practical and honest application of forms, features, and materials.
Public Domain	Extents of buildings that are available to the public.
Primary Façade	The main, public-facing side of a building, often with an entrance.
Regulating Plan	A form-base zoning code that establishes rules and regulations that guide the modulation of the whole building form in terms of acceptable locations on site, heights, bulk planes, setbacks, etc.
Secondary Façade	The side of a building that is not the primary façade, and fronts a public or private right-of-way; sometimes has a secondary entrance.
Shed Roof	A single-sloped roof form.
Secondary Building	A building defined by its use as being supportive to its overall context and is not a premier building.
Tactile	A condition that encourages touch and human sensory behavior.



# 2 CHARACTER & ENVIRONMENT

## **GOAL**

The architectural character of a town is defined by the collective feeling that it creates. Major factors in defining a unique architectural character are: referencing, versus duplicating, historic and authentic precedents, fostering tangible relationships between buildings and pedestrians, remaining complementary to setting and context, and responding to the local natural environment.



## DRAW AUTHENTICITY FROM HISTORIC ARCHITECTURE

**Objective:**

Designs should symbolically relate to Dillon's past to ensure that the Town's architecture conveys an aesthetic consistency that is supported by its location and history. Designs should not imitate historic precedents, but utilize their character and patterns to remain authentic.



CE1.1



CE1.2



CE1.3

Draw inspiration from mining building features such as piers, diagonal bracing, exposed structure, simple massing forms, and metal roofing.

Historic features to note are: the false front façades (left), and the creative application of this historic feature in a contemporary, yet respectful manner (right), recessed and covered retail entries, storefront window frontages, and the vertically proportioned openings at the upper floors.



CE1.4



CE1.5

Historic Dillon buildings were modest in shape and ornament.

Draw inspiration from vertically proportioned homes with gable roofs from old mountain towns.



## DRAW AUTHENTICITY FROM HISTORIC ARCHITECTURE



CE1.6



CE1.7



CE1.8



CE1.9

Historic structures imbued an economy of means in their functionally pragmatic and elemental designs, as they avoided unnecessary ornament.

Historic features to note are the use of a homogeneous color palette for simple buildings, and the emphasized architectural features such as columns, balconies, and roof lines at primary buildings.

Horizontal, vertical, shake, and board and batten were prominent applications of wood cladding patterns.

Structural systems were rational and expressed outwardly, and the roofs that capped the simple building volumes below.



CE1.10

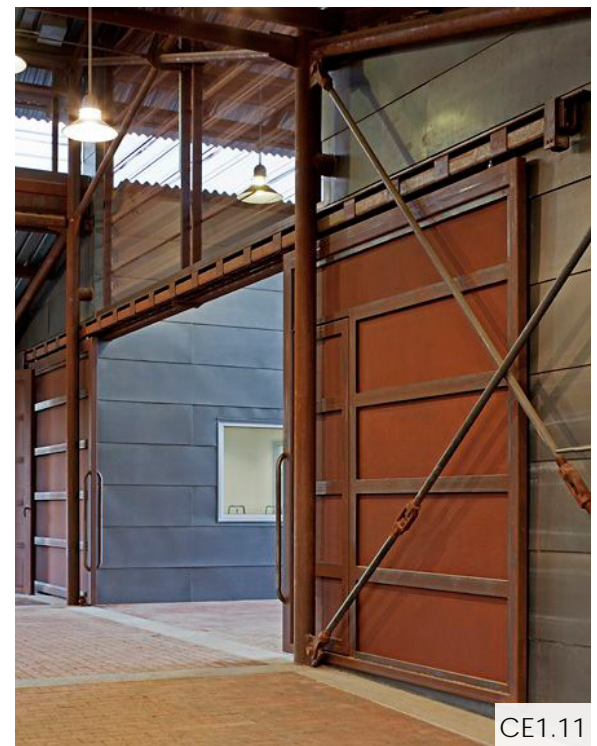

CE1.11

New buildings may include dynamic mining elements such as steel hoist-way pulleys to creatively connect with the past.

Draw inspiration from elements such as steel cross-bracing and barn doors on tracks to signify mountain ranching historic influences.



## DEFINE THE PUBLIC DOMAIN

### Objective:

Articulate, activate, and program the building base with publicly accessible uses that are open at night and on weekends.

**Buildings taller than 2-stories should incorporate a 2-story datum that faces the public right-of-way and has significant architectural character and detail to create a dynamic realm for the public.**

Maximizing visual connection is innate in a successful public setting. Views into, out of, and around buildings connects users with their environment and creates a comfortable place to inhabit.



CE2.1

The quality and character of each building should contribute to a coherent whole that reflects the Mountain Lakestyle aesthetic.

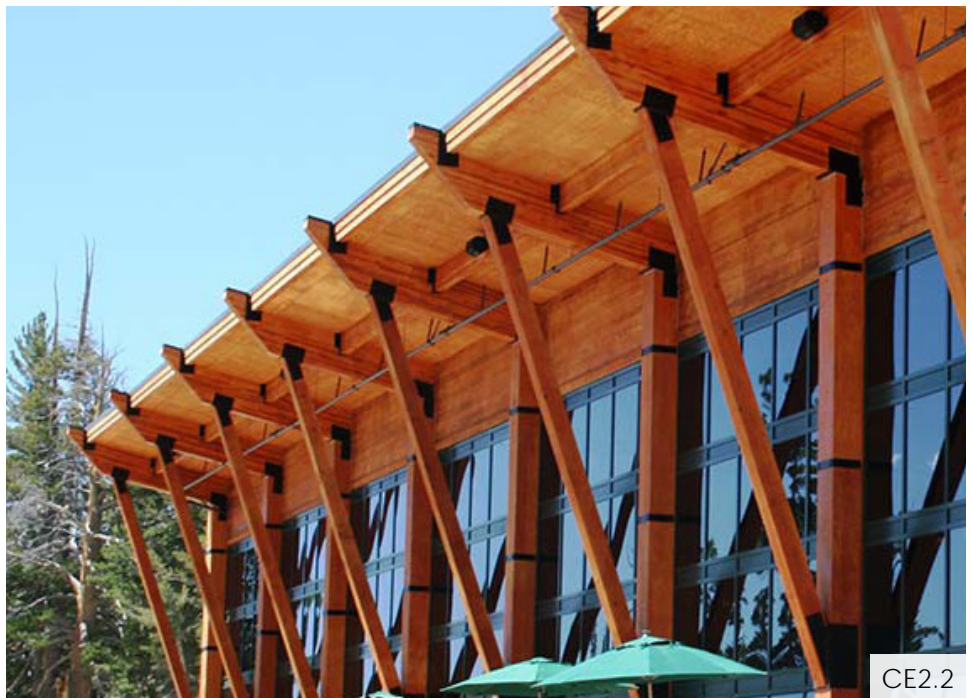

CE2.2

Create a desirable atmosphere by using principles of human-scale to relate to the pedestrian through projecting elements that reduce the scale of the façade, use exposed and detailed connections that portray human craft, and include arcades, awnings, or umbrellas that provide protection for congregating.



## DEFINE THE PUBLIC DOMAIN



CE2.3



CE2.4

Acceptable uses for the building base include dynamic commercial enterprises such as: retail, restaurant, bar, office, community space, lobbies, and the similar. To maintain a dynamic public domain, acceptable uses must extend more than 10' into the building before transitioning to an unacceptable use.



CE2.5



CE2.6

Unacceptable uses for the building base that do not contribute to the public domain include: hallways, stairs, back-of-house operations, storage, parking, and the similar.





## DEFINE THE PUBLIC DOMAIN



Tall floor-to-floor heights for commercial uses at the building base increases the marketability and presence of developed retail. **Relate the height of the base to the 2-story datum, where possible.**



**Floor-to-floor heights at grade level should be a minimum of 15' to emphasize visibility within the public domain.**

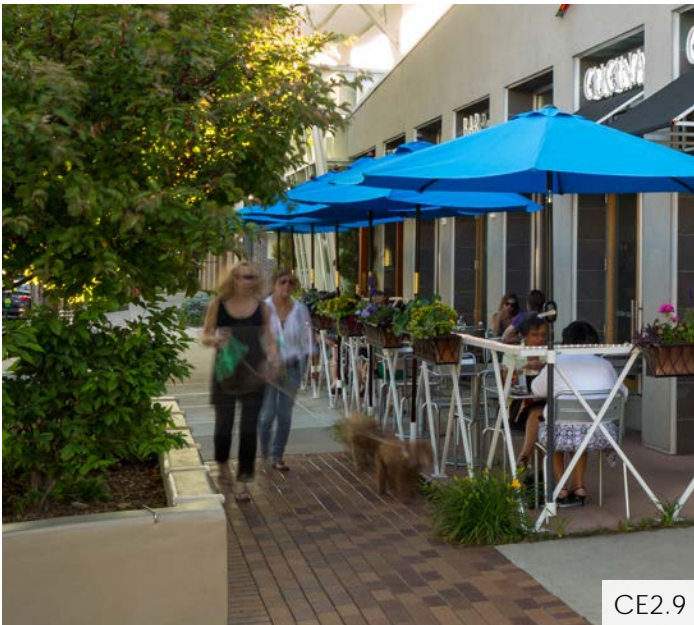

Activating the public domain with attractive landscape elements such as sidewalk trees, raised planters, window and patio-mounted planter boxes, outdoor patio seating, and varied sidewalk materials is encouraged.



Avoid overly opaque bases and window sills raised above 3' from grade. The lack of transparency diminishes the potential for street activation.



## DEFINE THE PUBLIC DOMAIN



CE2.11

Base articulation should try to include the use of durable and natural materials. Where storefronts are used, they should emphasize intricate and tactile details that relate to the craft of Mountain Lakestyle (see also 'Highlight the Craft') and create a personable impression. **Window sills should be no higher than 36"** to maintain a connection between inside and outside. Dark-colored mullions are encouraged; although light/natural wood mullions, or clear anodized aluminum mullions will be considered on a case-by-case basis if they relate to/harmonize with the overall building concept and surrounding context.



CE2.12

Each business is encouraged to participate in a community-building event by using custom-designed entry hardware that relates to their use or brand (ADA compliant).



CE2.13

Smaller buildings with more modulation can benefit from highly articulated storefronts with material changes, modulation, and color.



CE2.14

Larger buildings with less modulation should be simple, refined, and utilize a regular a proportional rhythm of glass to vertical mullion or pilaster.

**At the base of Primary façades, glazing should incorporate a ratio of 60% clear glazing:40% solid building, at a minimum. Secondary façades should attempt to incorporate as much glazing as possible.**



CE2.15

Standard entry hardware should be avoided since it is unspecific to Dillon and uninspiring.

Storefronts are character-defining features in a town center, and are intended to enliven retail façades through their signage, transparency, and display. **Storefronts should be simply detailed with emphasis on achieving consistent rhythm, proportion, and balance across the façade to allow for the retail environment to be the main focus.**

Vertical mullions should be used to emphasize or align with building features such as entries, shifts in building structure, or differences in function and use. Long, horizontal spans that do not use a vertical module are discouraged, unless they are consistent with the language of the overall architecture.



## DEFINE THE PUBLIC DOMAIN



CE2.16

Where possible, awnings and shading devices should be set below a band of clerestory glass to allow for maximum light penetration into the building interior. Work with Dillon P&Z to maintain proper clearance to bottom of the awning at the sidewalk snow removal machinery. Desired height to be 8' from grade to the bottom of the shade element, unless defined otherwise by Dillon P&Z.



CE2.17

Where appropriate, seamlessly extend roofs over the pedestrian walkways to protect from snow melt runoff. **Snow melt should always be redirected away from pedestrian zones below (see also 'Express the Roof Form' & 'Additional Graphic Submittal Materials').**



CE2.18

Where fabric awnings are desired, steeply slope to 1 horizontal unit:3 vertical units to mitigate the danger and damage of snow buildup and subsequent runoff. Simply designed awnings that span between extents of glass below is encouraged.



CE2.19

Where permanent awnings are appropriate, use simply designed timber or steel framing with metal roofing, or similar, for durability. **Design to either retain or runoff snow loads. For permanent awnings, designs can be a minimum slope of 3 vertical units:12 horizontal units.**



## DEFINE THE PUBLIC DOMAIN



CE2.20

Primary façades face the main street or the main pedestrian route. **They should incorporate the main building entrance, which should be prominent and visible from the street and/or public sidewalks or plazas to indicate a welcoming sense of entry.**

Secondary façades can be less prominent and less detailed, yet should support the design of the primary façade through their architectural features, materials, and/or alignments. Entrances and exits from secondary façades should be used to fulfill back-of-house or utilitarian uses.



CE2.21

Where all sides are visible to the public, buildings should incorporate 360 degree architecture, and be designed to the highest quality and attention to detail where visible from streets, sidewalks, plazas, parks, and any other pedestrian route. **Buildings with (3) or more façades visible from the public right-of-way should regard at least (2) façades as Primary façades.**

**Façade materials should wrap corners a minimum of 24" to convey depth and solidity.**



CE2.22



CE2.23

**Large expanses of walls with minimal articulation that are visible to the public are generally not acceptable.** If this portion of the façade cannot be glazed, the wall should be designed to incorporate honest and purposeful architectural features such as: façade modulation, exposed structure, upper clerestory glazing with shading devices for indirect light, branding/signage integrated into the architecture, and landscaped areas to soften the wall to ground relationship.



## CREATE COMPLEMENTARY DEVELOPMENTS

### Objective:

Draw upon the siting, massing, and character of adjacent or contextual developments. The design of individual buildings should be supported by its context to form a coherent whole.

The literal imitation of adjacent buildings or inappropriate application of historic styles to new construction is not acceptable.

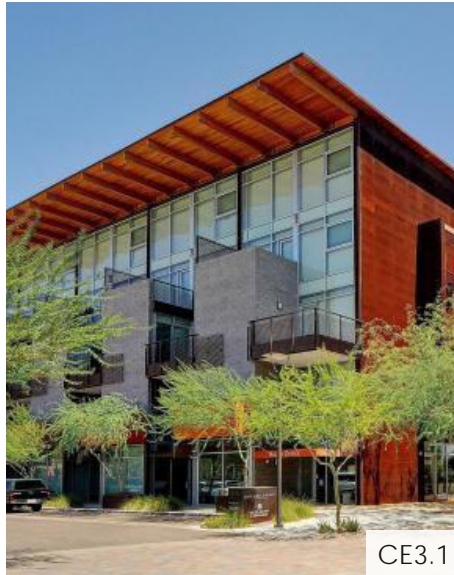

CE3.1

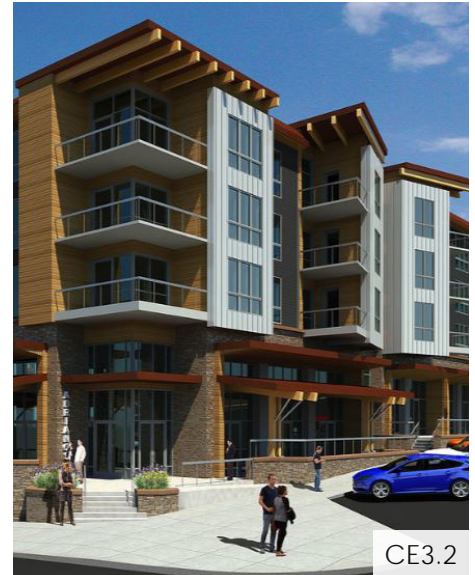

CE3.2

The example building (above left) constitutes a complementary design that utilizes similar siting, massing, and character of an actual proposed development for the town of Dillon (above right). Principle relationships in roof style, and façade elements such as balconies and datum lines reinforce the visual relationship between the two separate buildings.



CE3.3

Secondary buildings that are identified as supportive to a primary building should reflect their subordinate nature and integrate with their context. Primary buildings or jewel sites are encouraged to elevate the design aesthetic and character of their surrounding context. These special sites will be expected to utilize creative and innovative application of the Design Standards outlined in these Design Guidelines.



CE3.4

**National brands with specific exterior architectural design standards should adopt features from each category in these Guidelines to effectively enmesh with the Town's aesthetic.**



## TAKE ADVANTAGE OF THE CLIMATE

### Objective:

Designs should creatively maximize energy efficiency and minimize environmental impact, while maintaining a harmony with the Mountain Lakestyle aesthetic.



CE4.1

For a modern shading strategy, consider using open-style solar shades that integrate either materially or aesthetically with the structural style of the building, to appear as a component of the overall structural expression.



CE4.2

Make efforts to reduce energy requirements and glare by orienting roof slopes to capture direct southern light and balance it with indirect light from the north. Integrating exposed solar panels into the architecture and roof forms is encouraged.

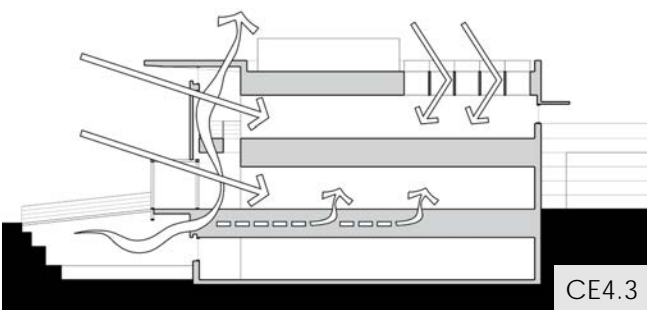

CE4.3

Consider sustainable strategies that contribute to the overall well-being of the inhabitants through natural ventilation and daylighting.

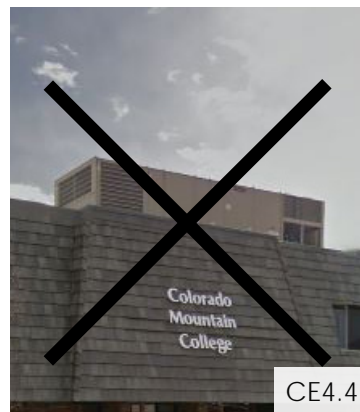

CE4.4



CE4.5

**Conceal rooftop utilities with roof features such as dormers, over-framed roof slopes, or parapets to preserve the purity of the roof skyline.**



# 2 CHARACTER & ENVIRONMENT

## DESIGN STANDARDS CHECKLIST

SECTION	APPLICANT Y/N	P&Z Y/N	P&Z COMMENTS
<b>DRAW AUTHENTICITY FROM HISTORIC ARCHITECTURE</b>			
Symbolic connection to historic architecture			
<b>DEFINE THE PUBLIC DOMAIN</b>			
2-story datum at buildings taller than 2 stories			
Building base use(s) meets intent of acceptable uses			
Base height relates to 2-story datum, where possible			
15' floor-to-floor height at grade level			
Window sills no higher than 36"			
Storefront mullion colors to be dark (other finishes approved on a case-by-case basis)			
Glazing meets or exceeds 60% transparent/40% solid ratio at <u>primary façade</u> base			
Simply detailed storefront design			
Roofs/awnings designed for snowmelt mitigation			
Fabric awning slope 1:3			
Permanent awning slope 3:12			
Primary façade to have main building entrance			
(2) primary façades for buildings with (3) façades visible from public right-of-way			
Façade materials should wrap corners a min. of 24"			
Blank walls visible to the public are not acceptable			
<b>CREATE COMPLEMENTARY DEVELOPMENTS</b>			
National brands adoption of these Guidelines for exterior architectural design			
<b>TAKE ADVANTAGE OF THE CLIMATE</b>			
Conceal rooftop utilities from sight			



# 3 BUILDING FORM & ARTICULATION

## GOAL

Building form and articulation should architecturally relate to the mountain and lake environments to reinforce the overall character and branding of Dillon. Façade proportions and layering should be inspired by classic architectural principles to invoke harmony across the Town; the connection of the building to the ground should be emphasized, building roofs should always be a character-defining feature. Building façades above the 2-story datum should be visually subservient to the base articulation while incorporating structural expression, recesses, and projections that respond to program, daylight, and functionality.





## EXPRESS THE BASE, MIDDLE, & TOP

### Objective:

Achieve architectural harmony across the Town by articulating building façades into [3] distinct layers: Base, Middle, and Top.

The Base layer should be comprised of sturdy materials that grounds the building with weight and stability, and is an intricate and dynamic zone that relates to the public domain. The Middle layer should appear subservient to the Base and the Top, with a more simplified use of cladding materials, projections, and colors. The Top layer should be a dominant form that caps the architecture below. **Applicants should describe their design strategies for each layer within their Design Narrative.**

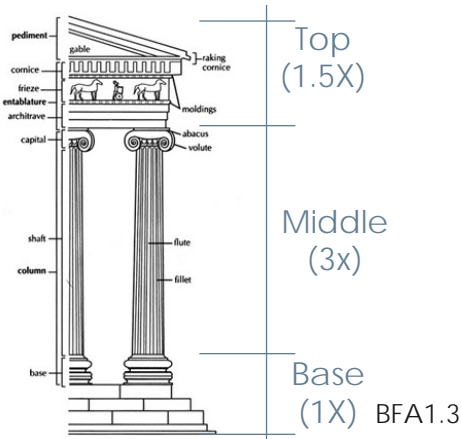

Base, Middle, and Top layers originated from classical architecture rules developed to proportion façades to be visually relatable. Note that the application of classical rules does not imply the approval to imitate classical architecture.



### Base layer:

Develop consistent expressions of proportion, rhythm, materials and detailing that are distinctive and human-scaled. Emphasize mountain or lake contextual influences:

[Mountain] Use of heavy expressions such as a combination of wide pilasters and punched openings with deep recessed glazing, or [Lake] Light expressions such as large glazing with columns that are narrow in profile and more frequent. The Base layer should be clearly differentiated in material and depth from the layers above.

### Middle layer:

The Middle layer should simplify the rhythm and character of the Base through fenestration patterns and/or expressed structure. The Middle layer is intended to convey patterns that are visually legible from a greater distance than the base.

### Top layer:

The Top layer should cap the building volume(s) with a roof or collection of roofs that draws interest from afar. Well-proportioned and articulated shed, or gable roofs (see also 'Express the Roof Form') are encouraged to appropriately represent the primary or secondary status of the building (see also 'Create Complementary Developments'). **Overly complex roofs or roof styles incompatible with these Guidelines are not acceptable.**



## EXPRESS THE BASE, MIDDLE, & TOP



### 1-story building:

- Minor Base
- Minor Middle
- Major Top

-or-

- Major Base
- Minor Middle
- Major Top



### 3-story building:

- Minor Base
- Major Middle
- Minor Top

-or-

- Major Base
- Minor Middle
- Major Top



### 5-story building:

- Minor Base
- Major Middle
- Minor Top

**The proportional rules to articulate a building into Base, Middle, and Top layers applies to buildings of all heights.** It is important to note that these layers should not be equal in height to each other, but should contain proportional hierarchy of major and minor, as exemplified above.



## EXPRESS THE BASE, MIDDLE, & TOP



BFA1.7



BFA1.8



BFA1.9



BFA1.10

Articulation of the façades of the building into layers is best achieved through deep modulation of the façade volumes. Material changes or the use of features such as façade projections are acceptable methods of delineation between layers. Ensure maximum depth is achieved at material changes to convey an honesty in application.



BFA1.11



BFA1.12

Buildings that do not exhibit a definitive Base, Middle, and/or Top are not acceptable, as their massing does not relate to their context.



## EXPRESS THE BUILDING WEIGHT & STRUCTURE

### Objective:

Buildings should visually express their apparent weight through the use of columns, structural framing, ratio of solid-to-transparent massing, and façade materials.

A defining feature of Mountain Lakestyle is the expression of apparent weight, and the manner in which it is translated to the ground. Traditional mountain buildings are heavy and protective, whereas traditional Lake buildings are more open and delicate.

The decision to either solidly or lightly connect the building's weight to the ground should be based on the surrounding contextual character of the buildings, proximity to the lake vs. the mountains, the requirements of the structural system, and the appropriate amount of transparency at the base. **Buildings closer to the Town of Dillon entrance, which share character and visual relationships with the mountains, are to consider designs that solidly connect to the ground. Buildings that are within visual or immediate proximity to Lake Dillon Reservoir are to consider designs that lightly translate their weight to the ground. Applicants should describe which emphasis their design employs within their Design Narrative.**



SOLID CONNECTION

BFA2.1

For buildings that solidly connect to the ground - emphasize heavier materials at the base such as: stone or masonry, and utilize punched openings with infilled glazing (see also 'Define the Public Domain'). The weight of the expressive roof, projecting building massing articulations, and/or balconies, should visually translate through the building down to the base (see also 'Express the Base, Middle, & Top').



LIGHT CONNECTION

BFA2.2

For buildings that lightly connect to the ground - utilize more frequent and smaller-scaled columns that integrate into the façade. The articulated rhythm of the column spacing at the base should translate up through the Middle to the Top layer (see also 'Express the Base, Middle, & Top'). Emphasis of the detailed and delicate connection to the ground is recommended.



## EXPRESS THE BUILDING WEIGHT & STRUCTURE



Examples of unacceptable buildings that do not express their weight and connection with the ground.



Examples of acceptable buildings that express their heavy weight and solidly connect with the ground.



Examples of acceptable buildings that express their minimal weight and lightly connect with the ground.



## BUILDING HEIGHTS & VIEW CORRIDORS

### Objective:

Create a carefully developed Town of Dillon that preserves view corridors of the surrounding natural mountain and lake environments.

Building heights should relate to their program(s), adjacent buildings, present code, and should consider the pedestrian scale and penetration of sunlight into the public domain.

With the desire for increased density in the Town Center, sensitivity to the adverse affects of ill-conceived building placements and heights to sunlight, views, and ventilation is paramount.

**Above the 2-story datum, (see also 'Define the Public Domain') building façades should be articulated by stepping the façade, or incorporating recesses and projections, to differentiate the building mass above the 2nd story from the building base.**



BFA3.1

Buildings heights and articulation should attempt to preserve adequate sunlight and view from the public right-of-way, where possible. Building heights should always allow for cross-ventilation through public spaces, while protecting from the northwesterly winds.



A drastic jump in scale

BFA3.2



Jewel Building

BFA3.3

Do not project buildings drastically above neighboring buildings unless for an approved jewel building use. Height and scale of each building should be compatible with their adjacent developments, transitioning gradually from one building to the next (see also 'Create Complementary Developments').



## EXPRESS THE ROOF FORM

### Objective:

Create sloping roofs that reflect the Mountain Lakestyle architecture of Dillon, where the roof is a major character-defining feature.

Roof designs should emphasize the presence of a 'Top' that caps the building volumes below (see also 'Express the Base, Middle, & Top').

Sloped roofs should be 5:12 minimum (unless flat), and 12:12 maximum (or steeper for approved iconic uses). Roof slopes should be consistent along the length of their rake yet should break to express the building program or adapt to their surrounding built and environmental context. Simple forms are preferred over complex roof forms.

Roof projections such as permanent awnings can be sloped at 3:12 minimum.



Mansard roof forms are not acceptable, as they do not contribute to Dillon's history or the Mountain Lakestyle aesthetic.



The gable roof should be the dominant roof form among new developments. Acceptable alternative forms are: shed, hipped, and flat (flat to be accepted on a case-by-case basis). **Roofs should be designed with a singular primary roof, oriented along the main axis of the building. A collection of secondary roof forms along the minor (axis/axes) are acceptable to break up the roof massing. Ultimately, the roof or collection of roofs should remain unified as a simple, yet powerful character-defining feature.**

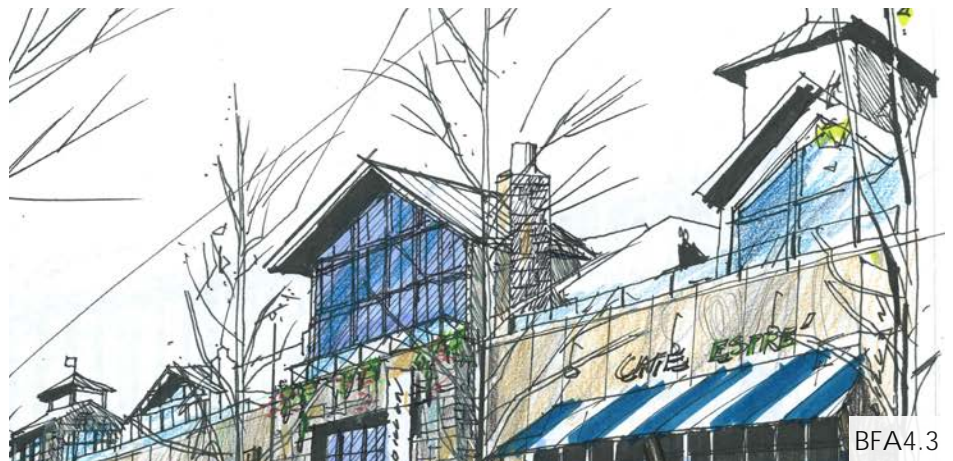

Varied roof forms, slopes, and massing heights create separate volumes within a large building mass. Maintain consistency in roof shapes to create a harmonious solution.



## EXPRESS THE ROOF FORM

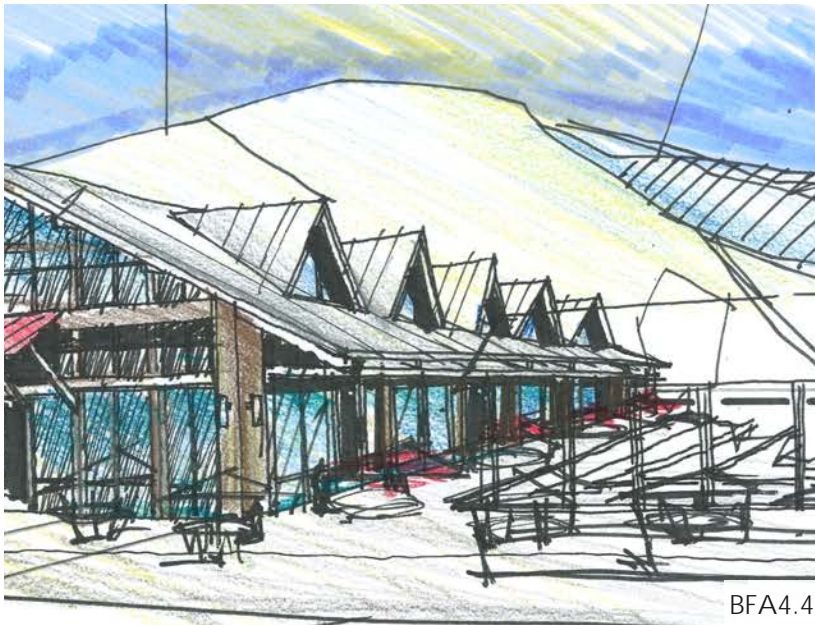

BFA4.4

Dormers are a secondary roof feature utilized to create a hierarchy in roof forms. **Dormers should be used in a consistent rhythm, and either be recessed no less than 3' from the eave edge, or outwardly project past the eave edge to engage the building massing below.**

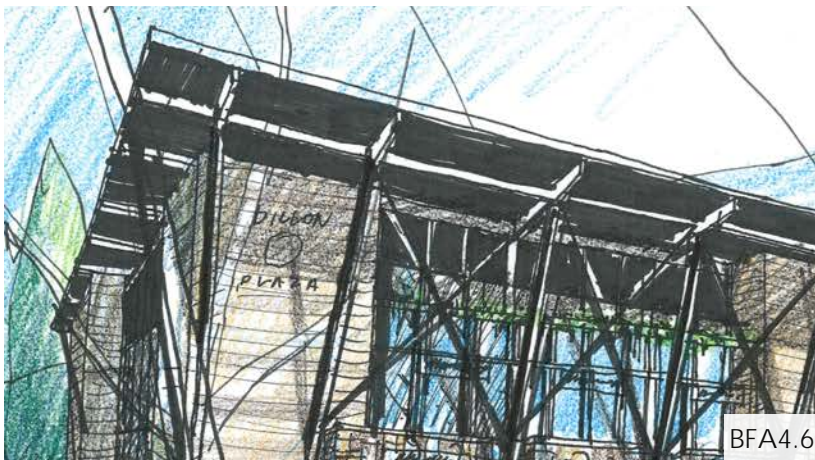

BFA4.6

Design roofs over large areas of glazing with a proportionate overhang supported by beams, outriggers, and/or brackets, to create a visually dynamic shading zone. Overhangs shall be proportional to the mass and identity of the building. **Shed and gable roofs should overhang 24" minimum at primary façades and 18" minimum at secondary façades.** If building placement does not allow for an overhang, the design of the roof overhang shall require special attention to the detailing at the transition from the roof to the wall.



BFA4.5

Vertical projections such as chimneys and cupolas should be located near the roof ridge line to pronounce their presence and avoid moisture build-up at their juncture with the sloping roof. Cupolas should be inhabitable or functional in use as a rooftop amenity such as a mechanical unit housing, and not inauthentic, or unusable.

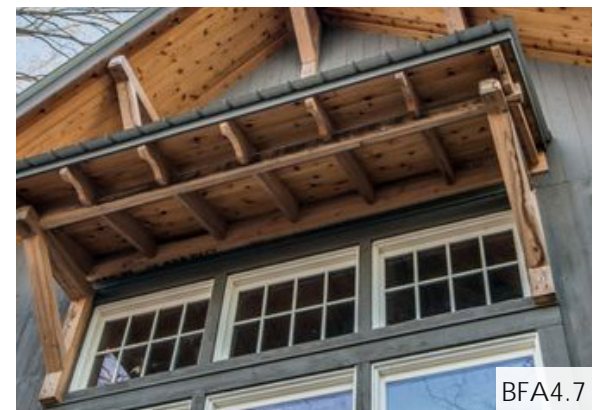

BFA4.7

**Overhangs larger than 18" should emphasize their cantilever through structural beams, outriggers, and/or brackets that terminate at the eave. Exposed ends of these elements should be no less than 2"x2" to depict their structural value.**





## EXPRESS THE ROOF FORM

Roof Designs for Large Buildings - Acceptable and unacceptable roof principles



### Unacceptable

- Limited roof articulation along the extensive length of building (only at entry).
- No architectural connection to local environment and Mountain Lakestyle character



### Acceptable

- Simple, character-defining roof form that engages building volume below.
- Clear Base, Middle, and Top layer distinction. Appropriately scaled roof for massing volumes below.



### Unacceptable

- Non-existent roof that leaves volumes below uncapped.
- No architectural connection to local environment and Mountain Lakestyle character



### Acceptable

- Simple, yet varied roof forms and building volumes to reduce building massing.



## EXPRESS THE ROOF FORM



BFA4.13

Where minimal to no overhang is desired due to aesthetic consistency, or if required due to site constraints, blend the roof form into the wall. Consider using consistent roof and wall materials, as well as the solid expression of roof to wall at the gable ends.



BFA4.15

Gutters should be box shape and match the roof in color and material, if possible. Gutter depths are encouraged to appear integrated with the eave by matching the eave's depth or matching a module of the eave.

The design of roof slopes and overhangs should carefully consider snow and ice runoff to protect the safety of the pedestrians and property below. Where structurally acceptable, snow fences that integrate into standing seams, or cleats that mount directly to the roofing material are recommended to retain snow to allow it melt prior to shedding off of a sloped roof. Snow mitigating elements should have a regular pattern that matches the roof pattern, appear visually unobtrusive to the architecture, and match the color of the roof, where possible.

**A roof runoff mitigation plan is required for projects that incorporate roof work (see also 'Additional Graphic Submittal Materials').**

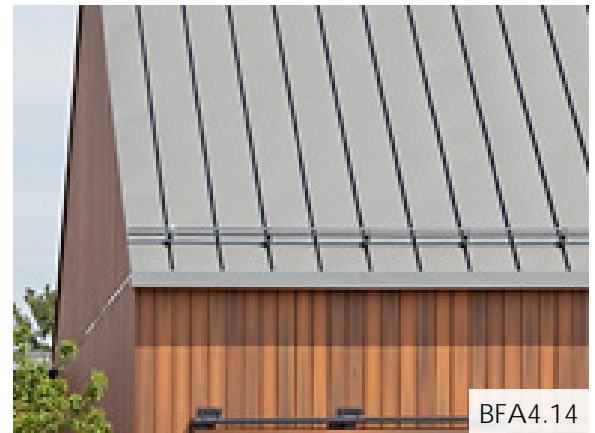

BFA4.14

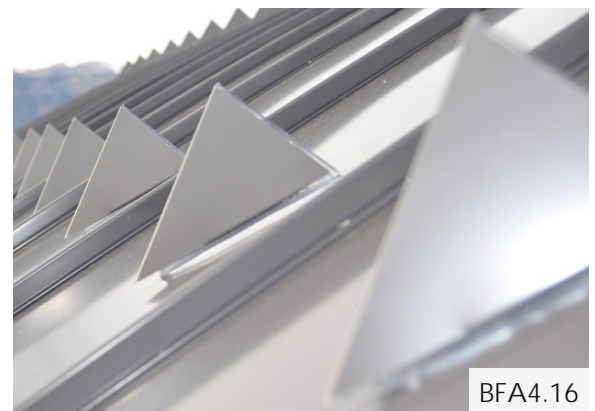

BFA4.16



## CREATE RECESSES & PROJECTIONS

### Objective:

Building entrances should be integrated into the rhythm and thickness of the façade, to protect those entering or exiting from immediate exposure to the elements.



BFA5.1

Buildings in the original downtown Dillon used recessed storefront entries, projecting displays, and awnings to connect with pedestrians.



BFA5.2



BFA5.3

Designs should protect building entrances through the use of projections such as roof overhangs, permanent awnings (see also 'Define the Public Domain'), and balconies.



BFA5.4



BFA5.5

Projections and recesses contribute to the overall articulation of the façade. Locate occupiable features such as balconies where practical. Balconies can be a solid projection of the façade material that appears to deepen the façade, or an open wood or steel-framed element that is structurally supported by the façade. Recesses can be used to engage the pedestrian at the ground level and create protected areas at upper levels. **Ensure that the use of projections and recesses addresses drainage in a visually unobtrusive manner.**



# 3 BUILDING FORM & ARTICULATION

## DESIGN STANDARDS CHECKLIST

SECTION	APPLICANT Y/N	P&Z Y/N	P&Z COMMENTS
EXPRESS THE BASE, MIDDLE, & TOP			
Articulate building façades into Base, Middle, & Top			
Description of Base, Middle, & Top in Design Narrative			
No overly complex roofs or incompatible roof styles			
Use of proportional rules for Base, Middle, & Top			
EXPRESS THE BUILDING WEIGHT & STRUCTURE			
Description of contextual influence emphasis relative to apparent weight: Mountain or Lake			
BUILDING HEIGHTS & VIEW CORRIDORS			
Modulate façades above 2-story datum to differentiate from building base			
EXPRESS THE ROOF FORM			
Emphasize Top layer that caps building volumes below			
5:12 minimum, and 12:12 maximum roof slope (steeper is acceptable if <u>Jewel building</u> )			
3:12 min. roof slope for projections/permanent awnings			
No mansard-style roof forms			
Simple, powerful, character-defining roof(s)			
Dormers set in a consistent rhythm, set 3' back from eave edge or projecting past eave edge			
Shed and gable roofs: 24" min. roof overhang at primary façades, 18" min. roof overhang at secondary façades			
Use of structural beams, outriggers, and/or brackets at 18" + roof overhangs. 2" x 2" minimum dimension for exposed support ends			
Roof runoff mitigation plan			
CREATE RECESSES & PROJECTIONS			
Use of projections to protect building entrances			
Concealed drainage at projections			



# 4 CRAFT, MATERIALS, & COLORS

## **GOAL**

The smallest scale of architecture is the most important contributor to the identifiable character and personality of a building. Buildings should express their highly crafted construction, be timeless in their use of quality materials, and revere both nature and vibrancy in their colors.



## HIGHLIGHT THE CRAFT

### Objective:

Building elements should reference historic craftsmanship and activities through architecture that features mountain and lake style construction methods.

**Utilize or mimic authentic fastening and joinery methods to develop a rich sense of timeless architecture.**



CMC1.5



CMC1.1



CMC1.2

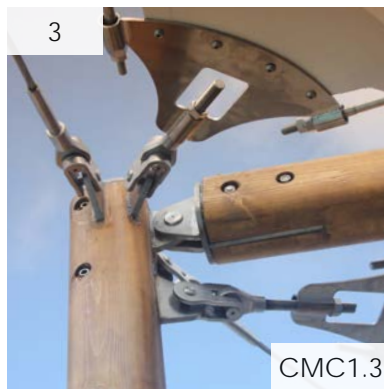

CMC1.3



CMC1.4

To develop unique architecture that is characteristically from the Town of Dillon, it is highly encouraged to borrow and combine contemporary and classic elements from mountain and lake architecture such as:

- 1 Steel flitch plates and bolts to join structural members with wood.
- 2 Steel tie rods and turnbuckles to express the elements that are supported in tension, such as timber posts, brackets, or even balconies and trellises braced from above.
- 3 Creatively integrate ropes, pulleys, clevises, and sail fabric to acknowledge the unique experience of sailing amongst the mountains that Dillon provides.
- 4 Incorporate nautical references of forms, styles, and materials that relate to the marina and the construction of boats.



## HIGHLIGHT THE CRAFT



Seek opportunities to create dynamic façades that foster a tactile relationship with the building, using operable elements such as: window shutters, large folding windows, glass garage doors, or even manual or mechanized screens that open to become overhead sun shades.

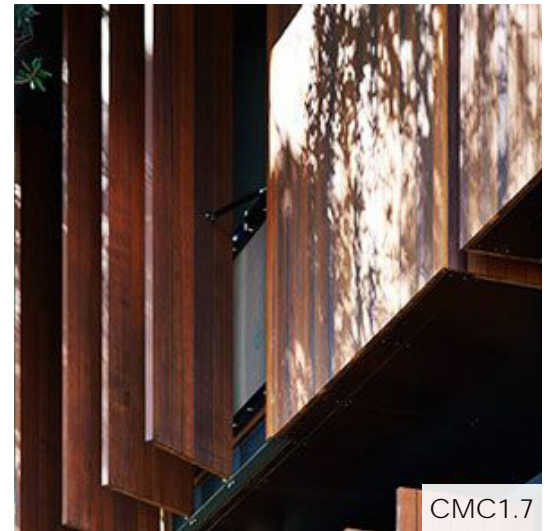

Designs should utilize pragmatic and highly crafted architectural features to enrich the character of the building.



# USE LOCAL MATERIALS & TEXTURES

## Objective:

Use local, durable, and timeless materials that contribute to the high quality for the Town of Dillon. Feature architectural elements with materials that contribute to the Mountain Lakestyle aesthetic. **Although projects should strive to utilize a simple material palette, a minimum of [2] wall materials is required.**

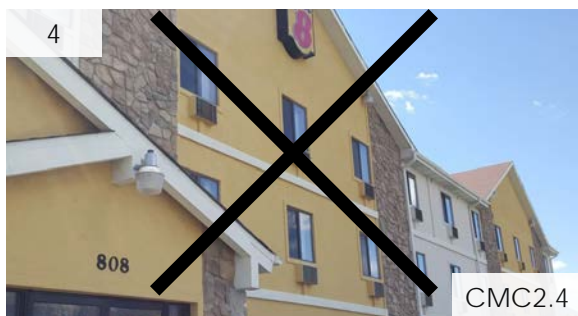
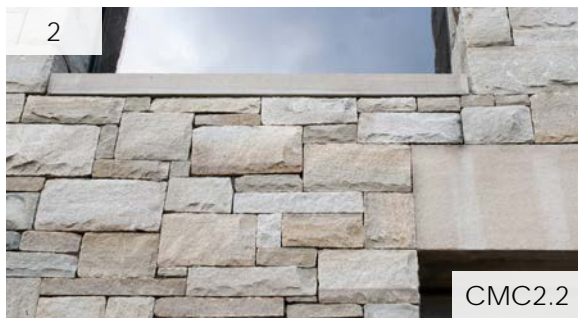

## STONE & MASONRY

### 1 Types

Natural stone is the most appropriate and desired type of stone cladding, but can be cost prohibitive. Use natural stone with a narrow grout thickness whose color closely matches the color scheme of the stone. If using engineered stone, ensure there is a subtle variety in color, scale, and shape to appear similar to qualities of natural stone. **The minimum height for engineered stone should be 4", with the desire to achieve an average of 8-12", or taller.** Proposed stone sizes that differ will be reviewed on a case-by-case basis.

**Materials should wrap building corners a minimum of 24" (see also 'Define the Public Domain'), and should enhance the visual depth of recesses or projections at volume modulations.** Building corners should appear thick, as if real large stones are used, and alternate their long edges in an inconspicuous pattern to reinforce a 'natural and stacked look'.

### 2 Accents

Use stone accents such as: sills, wall caps, wainscot caps, and trim, with either a snapped edge to achieve a subtle natural appearance, or a honed edge to achieve a clean and contemporary appearance.

### 3 Finish, Patterns, & Textures

Seal stone with a matte sealer to avoid creating an artificial gloss on a rough material. **Acceptable stone wall patterns should follow the principles of an ashlar pattern, with coursing comprised of modular stone heights, yet remaining irregular in overall look.**

### 4 Unacceptable Application

Example of an unacceptable flat façade with lack of modulation of recesses and projections, and materials that appear thinly applied vs. volumetric.





## USE LOCAL MATERIALS & TEXTURES

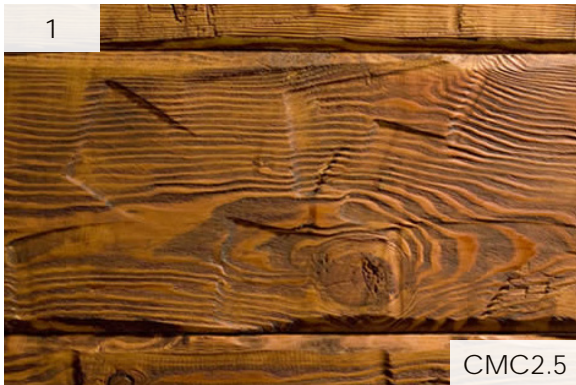

### WOOD

#### 1 Types

The use of natural wood for structural elements such as columns, beams, brackets, rafters, etc. is recommended. **If timbers are used, they should appear natural with a rough-sawn or hand-hewn finish. Natural wood used for cladding in a siding or rainscreen manner is also encouraged.**

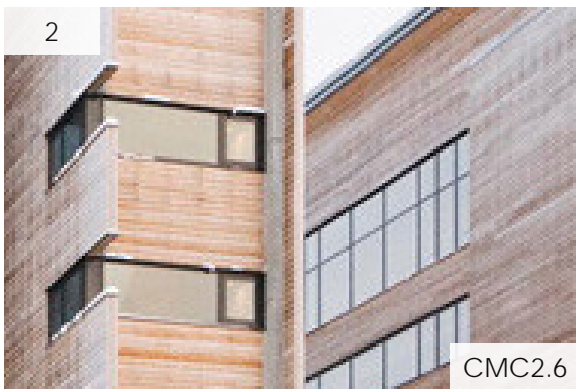

Engineered wood is an acceptable substitution for both structural and cladding applications, although preference for natural timber should be made for significant design features such as for roof supporting structure.

#### 2 Accents

Wood trim should be used minimally at the larger building masses such as the 'Middle' (see also 'Express the Base, Middle, & Top'). Trim should be used to emphasize thickness and weight of a design feature in a manner similar to a roof fascia.

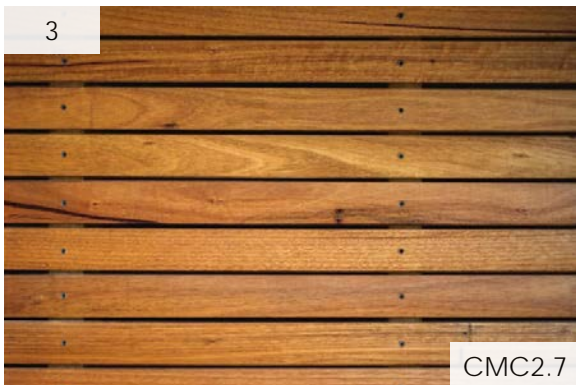

Detail in wood trim and paneling should be focused at the building base (see also 'Define the Public Domain, and 'Express the Base, Middle, & Top'). Use accents as opportunities to highlight well-crafted elements that relate to the character of Mountain Lakestyle.



#### 3 Finish, Patterns, & Textures

Exposed wood structure should be protected on its upper and exposed ends with an exterior-rated sealant and/or integrated flashing.

**Acceptable wood cladding patterns are horizontal or vertical rainscreen, clapboard, and board and batten.** Consider relating the orientation of the siding to the overall proportion of the mass it is cladding. Orienting the siding vertically accentuates the height of a volume, while orienting horizontally accentuates the length of the volume.

An acceptable example of clapboard façade cladding.



## USE LOCAL MATERIALS & TEXTURES

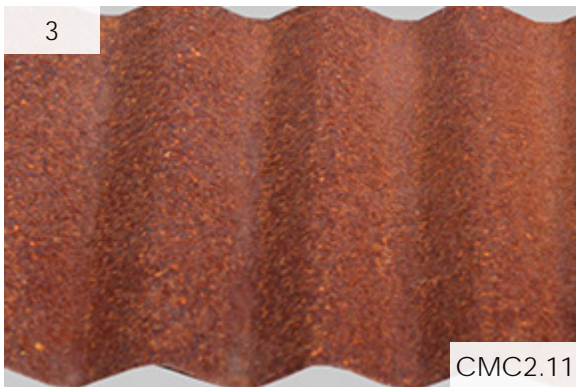

### METALS

#### 1 Types

The use of metal for building features such as columns, beams, trusses, connectors, cladding, roofing, window and door frames, louvers, grilles, and ornament is encouraged.

Where appropriate, emphasize the use of structural steel elements and details to reinforce the tectonic relationship of disparate building elements.

Aluminum, steel, or wood storefronts are encouraged to allow for maximum glazing and thermal performance.

#### 2 Accents

**The use of metal should be relegated to primarily roof applications, with occasional acceptance as a wall accent material.**

Structural connectors such as fitch plates, tie rods, timber tie plates, bolted connections, etc. are encouraged.

#### 3 Finish, Patterns, & Textures

To protect from the elements, seal or paint all metals, or select a pre-finished coating. Corten, galvanized metal, and other weathering/ weatherproof metals are acceptable as unfinished, if prevented from bleeding their surface colors once installed.

**Acceptable metal wall and roof patterns are: standing seam, corrugated, or shingle styles, as they relate to the mining and marina environments.**

#### 4 Unacceptable Application

Example of an unacceptable extent of metal wall panels that exceed an accent application.



## USE LOCAL MATERIALS & TEXTURES



### GLASS

#### 1 Extents & Types

Commercial building façades fronting public right-of-ways should incorporate a clear glazing ratio of 60% to activate the building frontage (see also ‘Define the Public Domain’).

Transparent or vision glass with no more than 10% light reduction is preferred for storefronts. **Opaque films or spandrel glass is allowed at floor transitions and as a means to create privacy, but is not encouraged to be used within the Public Domain, as it flattens the dynamic properties of the storefront (see also ‘Define the Public Domain’).**

#### 2 Accents

Creative and innovative glass accents that relate to the local environment such as louvers and guardrails is encouraged to further the characterization of Mountain Lakestyle.

#### 3 Patterns

Where patterns applied to glazing is appropriate, the use of color-tinted and fritted patterns can contribute to energy efficiency, privacy, and a sense of vibrancy.

#### 4 Unacceptable Application

Example of an unacceptable extent of blackout tint on storefront glass used within the public domain.



## USE LOCAL MATERIALS & TEXTURES



### ADDITIONAL MATERIALS

Acceptable additional materials are:

- 1 Stucco with a smooth finish is preferred. **Application of stucco is encouraged on the Middle layer, and is not recommended for the Base layer, as it is a less durable and historically accurate base material. (see also 'Define Base, Middle, Top').**
- 2 Fiber cement panels with exposed or hidden fasteners, installed in clean patterns such as: panelized, vertical or horizontal rainscreen, clapboard, and board and batten.
- 3 Resin-based wood products can be used as a durable alternative to natural wood cladding. Acceptable patterns are: vertical or horizontal rainscreen, or directly fastened application.
- 4 Fabrics used for awnings, or creative features such as tension roofs or removable sail-shades are encouraged, as long as they are designed appropriately for snow loads.



## COLOR PALETTES & ACCENTS

### Objective:

Select appropriate colors for the building façade, roofs, and accents features that harmonize with the overall Mountain Lakestyle appearance of the community and are compatible with their surrounding natural environment.

**Storefront mullions should be darker in tone, clear-anodized aluminum can also be accepted if deemed appropriate (see also 'Define Public Domain'). Exposed hardware and connectors should be dark to read as supportive elements. If a stainless steel finish is desired, provide a supporting argument in the Design Narrative.**



CMC3.1

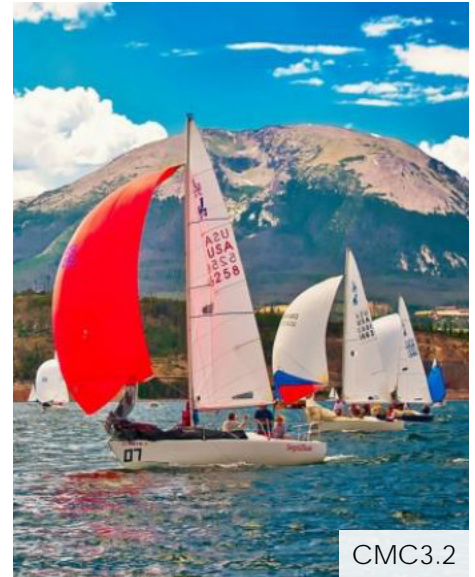

CMC3.2

**In general, colors and materials should appear more natural than artificially manufactured to retain a locally crafted aesthetic.** The careful combination of muted natural colors from the mountain environment, with accents that portray the marine colors from the lake, and the sails and flags from the sailboats, is encouraged for lake-influenced buildings (see also 'Complementary Developments').



### Façades

All façades should have a finished appearance. **Colors should range between medium to dark natural tones. Bright colors that do not harmonize with the natural palette of the town are unacceptable. The use of bright color as an intervention or a minor focal element in a façade is acceptable.**



### Roofs

**Building roofs should be natural in color, muted with low reflectivity, and darker in tone.** The use of galvanized metal to infuse elements of the lake is also acceptable. **Bright colors that do not harmonize with the natural palette of the town are not acceptable. The use of bright color as an intervention or minor focal element in a roof is acceptable.**



### Details & Accents

Detailed architectural elements such as trim, ornament, and structural elements should harmonize with the color palette of the façade and roof, unless desired to stand out as a special accent feature. Special accents adorned with brighter colors should be used minimally for design features, such as awnings or signage. **Limit accent colors to 10% max. to create interest and depth.**



# 4 CRAFT, MATERIALS, & COLORS

## DESIGN STANDARDS CHECKLIST

SECTION	APPLICANT Y/N	P&Z Y/N	P&Z COMMENTS
<b>HIGHLIGHT THE CRAFT</b>			
Utilize or mimic authentic fastening and joinery methods			
Pragmatic and highly crafted architectural features			
<b>USE LOCAL MATERIALS &amp; TEXTURES</b>			
Minimum of (2) primary façade materials			
Stone heights min. 4"H, with preference for 8-12"H			
Materials wrap building corners min. of 24"			
Ashlar pattern at stone cladding			
Rough-sawn or hand-hewn finish at timbers			
Use of acceptable wood cladding patterns			
Use of metal cladding for roof and/or wall accent only			
Use of acceptable metal wall and/or roof patterns			
Clear glazing ratio of 60% min. glazing to 40% solid			
Clear glazing with no more than 10% light reduction. No opaque films or glass at <u>public domain</u> .			
Stucco at building Middle layer, not Base layer			
<b>COLOR PALETTES &amp; ACCENTS</b>			
Darker tone storefront mullion color			
Natural color palette with combination of marine accents (if Lake style influences)			
Façade colors of medium to dark natural tones. Bright colors only used for interventions or minor focal elements.			
Roof colors of dark natural tones (unless galvanized), muted, low reflectivity, natural tones. Bright colors only used for interventions or minor focal elements.			
10% maximum area usable for accent colors on façades			



## IMAGE CREDITS

---

### 1 INTRODUCTION

- COVER Town of Dillon - Marketing Brand Platform Book, 2016
- i1.1 Unknown. *Forever Gone*. Images of America -  
Dillon and Silverthorne, Arcadia, 2009. 1. Print.
- i1.2 Town of Dillon - Marketing Brand Platform Book, 2016.

#### Aesthetic Position

- i1.3 Rendering courtesy of Roth Sheppard Architects

### 2 CHARACTER & ENVIRONMENT:

#### Draw Authenticity from Historic Architecture

- CE1.1 Brian, *Historic Mine*. Web. [www.bryan894x4.com](http://www.bryan894x4.com). 08 March 2017.
- CE1.2 Unknown. *Main Street, Dillon*. Images of America -  
Dillon and Silverthorne, Arcadia, 2009. 10. Print.
- CE1.3 Photo courtesy of Roth Sheppard Architects
- CE1.4 Unknown. *Spiritual Moment*. Images of America -  
Dillon and Silverthorne, Arcadia, 2009. 10. Print.
- CE1.5 Unknown source. Web. 08 March 2017.
- CE1.6 Unknown. *Unknown Title*. Web.  
[www.Shaunmossphotography.com/blog](http://www.Shaunmossphotography.com/blog). 08 March 2017.
- CE1.7 Unknown. *Unknown Title*. Web. [www.Colorado.com](http://www.Colorado.com). 08 March 2017.
- CE1.8 Unknown. *Unknown Title*. Web. [www.Colorado.com](http://www.Colorado.com). 08 March 2017.
- CE1.9 Unknown. *Marist's Historic Cornell Boathouse*. Web.  
[www.goredfoxes.com](http://www.goredfoxes.com). 30 January 2017.
- CE1.10 Unknown. *California gallery facade using gears and pulleys*. Web.  
[www.Dezeen.com](http://www.Dezeen.com), 08 March 2017.
- CE1.11 Ooms, Frank. *Unknown Title*. Web.  
[www.GH2equine.com](http://www.GH2equine.com). 08 March 2017.



## IMAGE CREDITS (CONTINUED)

---

### Define the Public Domain

- CE2.1 Unknown. *Peacefully Off-Season in Vail, Colorado*. Web. [www.roadesque.com](http://www.roadesque.com). 08 March 2017.
- CE2.2 Unknown. *Lodge\_G08*. Web. [www.baseballnationals.com](http://www.baseballnationals.com). 08 March 2017.
- CE2.3 Photo courtesy of Roth Sheppard Architects
- CE2.4 Photo courtesy of Roth Sheppard Architects
- CE2.5 Unknown. *Figure 13: Side elevation, Staunton Parking Garage*. Web. [www.blog.classicist.org](http://www.blog.classicist.org). 08 March 2017.
- CE2.6 Unknown. *Parking Garage, Winter Haven*. Web. [www.ck-arch.com](http://www.ck-arch.com). 08 March 2017. 08 March, 2017.
- CE2.7 Rendering courtesy of Roth Sheppard Architects.
- CE2.8 Rendering courtesy of Roth Sheppard Architects.
- CE2.9 Photo courtesy of Roth Sheppard Architects.
- CE2.10 Photo courtesy of Roth Sheppard Architects.
- CE2.11 Richard, Gregory. *Retail Renovation*. Web. [www.RemingtonArchitecture.com](http://www.RemingtonArchitecture.com). 27 January 2017.
- CE2.12 Unknown. *Unknown Title*. Web. [www.scottsdaleartfactory.com](http://www.scottsdaleartfactory.com). 27 January 2017.
- CE2.13 Unknown. *Peacefully Off-Season in Vail, Colorado*. Web. [www.roadesque.com](http://www.roadesque.com). 08 March, 2017
- CE2.14 Dunn, Casey. *H-E-B Mueller*. Web. [www.lakeflato.com](http://www.lakeflato.com). 08 March 2017.
- CE2.15 Photo courtesy of Roth Sheppard Architects
- CE2.16 Photo courtesy of Roth Sheppard Architects
- CE2.17 Unknown. *DSC02989.jpg*. Web. [www.holzarchitektur.ch](http://www.holzarchitektur.ch). 08 March 2017.
- CE2.18 Unknown. *The Northface Store*. Web. [www.vailsports.com](http://www.vailsports.com). 08 March 2017.
- CE2.19 Unknown. *Unknown Title*. Web. [www.Homesteadtimberandframes.com](http://www.Homesteadtimberandframes.com). 08 March 2017.
- CE2.20 Photo courtesy of Roth Sheppard Architects.
- CE2.21 Photo courtesy of Roth Sheppard Architects.
- CE2.22 Photo courtesy of Roth Sheppard Architects.
- CE2.23 Photo courtesy of Roth Sheppard Architects.





## IMAGE CREDITS (CONTINUED)

---

### Create Complementary Developments

- CE3.1 Unknown. *Safari Drive Condos*. [www.justaskeric.com](http://www.justaskeric.com). 08 March 2017.
- CE3.2 Rendering courtesy of the Town of Dillon.
- CE3.3 Van de Velde, Tim. *City Hall Harelbeke*.  
[www.archdaily.com](http://www.archdaily.com). 08 March 2017.
- CE3.4 Everett, John. *H-E-B Buffalo Market*. Web.  
[www.houston.culturemap.com](http://www.houston.culturemap.com). 08 March 2017.

### Take Advantage of the Climate

- CE4.1 Doran, Andrew. *Squamish Adventure Centre*.  
[www.sabmagazine.com](http://www.sabmagazine.com). 08 March 2017.
- CE4.2 Unknown. *Mountain Equipment Co-op North Vancouver*. Web.  
[www.ventanaconstruction.com](http://www.ventanaconstruction.com). 08 March 2017.
- CE4.3 Rendering courtesy of Roth Sheppard Architects.
- CE4.4 Rendering courtesy of Roth Sheppard Architects.
- CE4.5 Unknown. *Fielders Contemporary Dormer Vent Type 2*. Web.  
[www.steel.com/au](http://www.steel.com/au). 08 March 2017.

## BUILDING FORMS AND ARTICULATION:

3

### Express the Base, Shaft, & Top

- BFA1.1 Unknown. *Copperhill - a long awaited visit*. Web.  
[www.fjallkansla.se](http://www.fjallkansla.se). 08 March 2017.
- BFA1.2 Everett, John. *H-E-B Buffalo Market*. Web.  
[www.houston.culturemap.com](http://www.houston.culturemap.com). 08 March 2017.
- BFA1.3 Unknown. *Comparison of Ancient Greek Architectural Orders*. Web.  
[www.classicalwisdom.com](http://www.classicalwisdom.com). 08 March 2017.
- BFA1.4 Rendering courtesy of Roth Sheppard Architects.
- BFA1.5 Rendering courtesy of Roth Sheppard Architects.
- BFA1.6 Unknown. *Wellness Hotel Adula*. Web.  
[www.booking.com](http://www.booking.com). 08 March 2017.
- BFA1.7 Unknown. *Hotel Christophorus*. Web. [www.skittotal.com](http://www.skittotal.com). 08 March 2017.
- BFA1.8 Jones, Christopher. *The Globe Hotel / M3 Architecture*. Web.  
[www.archdaily.com](http://www.archdaily.com). 08 March 2017.



## IMAGE CREDITS (CONTINUED)

---

- BFA1.9      Dunn, Casey. *H-E-B Mueller*. Web. [www.lakeflato.com](http://www.lakeflato.com). 08 March 2017.
- BFA1.10     Unknown. *Lake Homes*. Web. [www.pinterest.com](http://www.pinterest.com). 08 March 2017.
- BFA1.11     Unknown. *Google Street View - Dillon, Co.* Web. [www.maps.google.com](http://www.maps.google.com). 08 March 2017.
- BFA1.12     Unknown. *Google Street View - Dillon, Co.* Web. [www.maps.google.com](http://www.maps.google.com). 08 March 2017.

### Express the Building Weight

- BFA2.1      Unknown. *141 East Meadow Drive*. Web. [www.ronbyrne.com](http://www.ronbyrne.com). 08 March 2017.
- BFA2.2      Unknown source. Web. 08 March 2017.
- BFA2.3      Unknown. *Google Street View - Dillon, Co.* Web. [www.maps.google.com](http://www.maps.google.com). 08 March 2017.
- BFA2.4      Unknown. [www.gmthrift.com](http://www.gmthrift.com). Web. 08 March 2017.
- BFA2.5      Rendering. *Kwidzyn Old Town Housing Proposal*. Web. [www.archdaily.com](http://www.archdaily.com). 08 March 2017.
- BFA2.6      Unknown. *Copperhill - a long awaited visit*. Web. [www.fjallkansla.se](http://www.fjallkansla.se). 08 March 2017.
- BFA2.7      Dunn, Casey. *H-E-B Mueller*. Web. [www.lakeflato.com](http://www.lakeflato.com). 08 March 2017.
- BFA2.8      Unknown. *Lake Homes*. Web. [www.pinterest.com](http://www.pinterest.com). 08 March 2017.

### Step Building Heights

- BFA3.1      Unknown. *Aristi Mountain Resort*. Web. [www.idesignarch.com](http://www.idesignarch.com). 08 March 2017.
- BFA3.2      Unknown. *Viceroy Snowmass*. Web. [www.viceroyhotelsandresorts.com](http://www.viceroyhotelsandresorts.com). 08 March 2017.
- BFA3.3      Jeong, Jay. *Aspen Art Museum*. Web. [www.jayjeong.com](http://www.jayjeong.com). 08 March 2017.

### Express the Roof Form

- BFA4.1      Rendering courtesy of Roth Sheppard Architects.
- BFA4.2      Unknown. *No Title*. Web. [www.coloradobeckmoms.com](http://www.coloradobeckmoms.com). 08 March 2017.
- BFA4.3      Rendering courtesy of Roth Sheppard Architects.
- BFA4.4      Rendering courtesy of Roth Sheppard Architects.
- BFA4.5      Rendering courtesy of Roth Sheppard Architects.



## IMAGE CREDITS (CONTINUED)

---

- BFA4.6 Rendering courtesy of Roth Sheppard Architects.  
BFA4.7 Unknown. *Unknown Title*. Web.  
www.Homesteadtimberandframes.com. 08 March 2017.  
BFA4.8 Unknown. *Google Street View - Dillon, Co*. Web.  
www.maps.google.com. 08 March 2017.  
BFA4.9 Unknown. *Wellness Hotel Adula*. Web.  
www.booking.com. 08 March 2017.  
BFA4.10 Dunn, Casey. *H-E-B Mueller*. Web. www.lakeflato.com. 08 March 2017.  
BFA4.11 Photo courtesy of the Town of Dillon.  
BFA4.12 Mork, Adam. *Frederiksvej Kindergarten*. Web.  
www.archdaily.com. 08 March 2017.  
BFA4.13 Rendering courtesy of Roth Sheppard Architects.  
BFA4.14 Photo courtesy of Roth Sheppard Architects.  
BFA4.15 Photo courtesy of Roth Sheppard Architects.  
BFA4.16 Unknown. *Snow Guards on roof in Jackson, WY*. Web.  
www.commons.wikimedia.org. 08 March 2017.

### Create Recesses & Projections

- BFA5.1 Unknown. *Main Street, Dillon*. Images of America -  
Dillon and Silverthorne, Arcadia, 2009. 10. Print.  
BFA5.2 Unknown Source. Web.  
BFA5.3 Dunn, Casey. *H-E-B Mueller*. Web. www.lakeflato.com. 08 March 2017.  
BFA5.4 Unknown. *Copperhill - a long awaited visit*. Web.  
www.fjallkansla.se. 08 March 2017.  
BFA5.5 Unknown Source. Web. 08 March 2017.

## 4 CRAFT, MATERIALS, & COLORS:

### Highlight the Craft

- CMC1.1 Millman, Matthew. *Mountain Wood Residence*. Web.  
www.walkerwarner.com. 08 March 2017.  
CMC1.2 Unknown. *Unknown Title*. Web.  
www.atimber.com. 08 March 2017.



## IMAGE CREDITS (CONTINUED)

---

- CMC1.3 Unknown. *Unknown Title*. Web.  
[www.tesnis-tensile-structures.blogspot.com](http://www.tesnis-tensile-structures.blogspot.com)
- CMC1.4 Unknown. *Unknown Title*. Web.  
[www.ndsparks.com](http://www.ndsparks.com). 08 March 2017.
- CMC1.5 Unknown. *Unknown Title*. Web.  
[www.iconicweddings.com](http://www.iconicweddings.com). 08 March 2017.
- CMC1.6 Dzikowski, Francis. *Wyckoff Exchange*. Web.  
[www.architecturelist.com](http://www.architecturelist.com). 08 March 2017.
- CMC1.7 Unknown. *Land House*. Web.  
[www.petersutchbury.com.au](http://www.petersutchbury.com.au). 08 March 2017.
- CMC1.8 Rendering courtesy of Roth Sheppard Architects.

### Use Local Materials & Textures

- CMC2.1 Tierney, Stephen. *House in Blacksod Bay*.  
[www.archdaily.com](http://www.archdaily.com). 08 March 2017.
- CMC2.2 Tierney, Stephen. *House in Blacksod Bay*.  
[www.archdaily.com](http://www.archdaily.com). 08 March 2017.
- CMC2.3 Tierney, Stephen. *House in Blacksod Bay*.  
[www.archdaily.com](http://www.archdaily.com). 08 March 2017.
- CMC2.4 Castro, Eyleh. *Super 8 Dillon*. Web.  
[www.google.com/maps](http://www.google.com/maps). 08 March 2017.
- CMC2.5 Unknown. *Douglas Fir Siding*. Web.  
[www.woodsource.com](http://www.woodsource.com). 08 March 2017.
- CMC2.6 Kullman, Jonas. *Copperhill Mountain Lodge*. Web.  
[www.archdaily.com](http://www.archdaily.com). 08 March 2017.
- CMC2.7 Unknown. *Pump House*. Web.  
[www.homeli.co.uk](http://www.homeli.co.uk). 08 March 2017.
- CMC2.8 Unknown. *Unknown Title*. Web.  
[www.jameshardiepros.com](http://www.jameshardiepros.com). 08 March 2017.
- CMC2.9 Millman, Matthew. *Mountain Wood Residence*. Web.  
[www.walkerwarner.com](http://www.walkerwarner.com). 08 March 2017.
- CMC2.10 Gundu, Bob. *Frogs Hollow*. Web.  
[www.archdaily.com](http://www.archdaily.com). 08 March 2017.
- CMC2.11 Unknown. *1/2" corrugated*. Web.  
[www.cortenroofing.com](http://www.cortenroofing.com). 08 March 2017.



## IMAGE CREDITS (CONTINUED)

---

- CMC2.12 Unknown. *Metal Wall Cladding*. Web.  
[www.constructionkit.com](http://www.constructionkit.com). 08 March 2017.
- CMC2.13 Richard, Gregory. *Retail Renovation*. Web.  
[www.RemingtonArchitecture.com](http://www.RemingtonArchitecture.com). 27 January 2017.
- CMC2.14 Unknown. *Biddeford Pool, Maine*. Web.  
[www.shapefabrication.com](http://www.shapefabrication.com). 08 March 2017.
- CMC2.15 Bitter, Jan. *Office Building in Cologne*. Web.  
[www.detail-online.com](http://www.detail-online.com). 08 March 2017.
- CMC2.16 Unknown. *Unknown Title*. Web.  
[www.abcsuncontrol.com](http://www.abcsuncontrol.com). 08 March 2017.
- CMC2.17 Photo courtesy of Roth Sheppard Architects.
- CMC2.18 Unknown. *Swisspearl fibre cement*. Web.  
[www.archiproducts.com](http://www.archiproducts.com). 08 March 2017.
- CMC2.19 Photo courtesy of Roth Sheppard Architects.
- CMC2.20 Unknown Source. Web.

### Color Palettes and Accents

- CMC3.1 Photo courtesy of Roth Sheppard Architects.
- CMC3.2 Unknown. *Sailing on Lake Dillon*. Web.  
[www.colorado.com](http://www.colorado.com). 08 March 2017.



**DILLON**  
COLORADO