

# EROSION AND SEDIMENT CONTROL DURING CONSTRUCTION



**Summit Water Quality Committee  
Summit County, Colorado**



**Prepared by:**

**BRIAN LORCH and LANE WYATT**

**July - 2000**

**TABLE OF CONTENTS**

**Chapter 1 — Introduction**  
 Land Development and Erosion . . . . . 2  
 Why is it Important to Control Erosion and Sedimentation? . . . . . 2  
 Erosion Control Regulations in Summit County . . . . . 3  
 Principles of Erosion and Sediment Control . . . . . 4

**Chapter 2 — Planning and Site Preparation BMPs**  
 Minimizing Disturbed Areas . . . . . 6  
 Vegetation Buffers . . . . . 7  
 Construction Scheduling and Phasing . . . . . 8  
 Considerations for Construction Scheduling . . . . . 9  
 Stormwater Diversion during Construction . . . . . 10

**Chapter 3 — Erosion Control BMPs**  
 Land Grading for Minimizing Erosion . . . . . 11  
 Infiltration Practices . . . . . 12  
 Surface Roughening and Terracing . . . . . 14  
 Revegetation . . . . . 16  
 Mulching . . . . . 18  
 Erosion Control Blankets . . . . . 20

**Chapter 4 — Sediment and Runoff Control BMPs**  
 Vehicle Tracking Controls . . . . . 22  
 Sediment Traps . . . . . 24  
 Check Dams . . . . . 26  
 Sediment Basins . . . . . 28  
 Sand Bags and Continuous Berms . . . . . 30  
 Silt Fences . . . . . 32  
 Straw Bale Barriers . . . . . 34  
 Channel Stabilization (or Channel Lining) . . . . . 36  
 Storm Drain Inlet Protection . . . . . 38  
 Outlet Protection (Energy Dissipaters) . . . . . 40  
 Road and Trail Drainage . . . . . 42  
 Slope Drains . . . . . 44

**Chapter 5 — Other Practices**  
 Pollutant Source Controls . . . . . 46  
 Winter Road and Parking Maintenance . . . . . 47

**Acknowledgments and References . . . . . 48**

**Appendix 1**  
 Erosion Control Toolbox of Best Management Practices . . . . . 50

**Appendix 2**  
 Summit County Recommended Revegetation Seed Mixture . . . . . 51

**I – INTRODUCTION****Land Development and Erosion**

Any activity that removes vegetation and other ground cover can accelerate natural erosion and sedimentation rates. Grading operations commonly trigger hundred-fold increases in rainfall erosion. The Federal Clean Water Act and State regulations require that the best practical measures be used to reduce offsite impacts on water quality. These measures are commonly called best management practices (BMPs). All jurisdictions in Summit County require that BMPs be used to minimize impacts of construction activities on water resources. This brochure presents information on a limited number of BMPs currently recommended to reduce the negative impacts of construction and development activities.

**Why is it Important to Control Erosion and Sedimentation?**

- Sand and silt fill in pools and cover the stream bottom, interfering with spawning and impacting fish eggs, insects, and newly hatched fish.
- Nutrients carried with sediment can increase algae, cloud water, cause odors, and degrade fish habitat.
- Sediment in water increases water treatment costs.
- Clean streams and lakes are preferred by recreationists and citizens.
- The State has created a water quality standard to control phosphorus levels and algae in Dillon Reservoir. Land disturbance is a principle source of phosphorus.
- The Federal Clean Water Act requires that runoff from construction activities be controlled to reduce or eliminate the impacts to water quality from sediment.
- All jurisdictions in Summit County have regulations to minimize the off-site movement of soil. State and Federal regulations also require stormwater management plans for construction sites over five acres (one acre in recent regulatory revisions).

## Erosion Control Regulations in Summit County

All local governments in Summit County have land use ordinances that condition construction and development activities to protect water quality. The details of these ordinances vary slightly from one jurisdiction to the next. However, development codes for the county and each town contain requirements that address the following:

- Any land disturbance must be set back a prescribed minimum distance from certain water bodies, including wetlands.
- Best management practices must be utilized on construction sites to prevent soil loss.
- Bare, exposed soil on a construction site must be protected from erosion by re-vegetating the site.
- It is prohibited to allow untreated water from a development site to discharge directly to any water body, both during and after construction.
- There cannot be an increase in the historic, pre-development peak runoff rate as a result of development activities.

### ***Other Requirements:***

*Construction activities that disturb five acres of land or more are required to obtain a stormwater construction permit from the Colorado Department of Public Health and Environment, Water Quality Control Division. This includes construction activities which are part of a larger common plan of development which disturb five acres or more.*

*Beginning mid-2002 the minimum size of construction projects needing permits will be reduced from five acres of disturbed area to one acre.*

## Principles of Erosion and Sediment Control for Construction

### *1. Retain and protect natural vegetation:*

Natural vegetation is the most efficient form of erosion control. In the harsh mountain climate it is difficult to re-establish vegetation. Vegetation reduces erosion by:

- Absorbing raindrop impacts
- Reducing runoff velocity
- Reducing runoff volume by increasing infiltration into the soil.
- Acting as an “anchor” to improve soil and slope stability

Therefore, strip only the area required for construction and stage grading so that only the portion of the site that will be constructed within the next 14-21 days is cleared of vegetation.

### *2. Time grading to minimize soil exposure during snowmelt and rainy periods:*

In the Central Rocky Mountains, spring snowmelt results in saturated soil conditions and the highest volume of natural runoff. Late summer thunderstorms result in high intensity runoff. Both of these hydrologic events cause erosion of unstable or disturbed soils. Therefore, it is best to schedule major grading work during early summer or late fall.

### *3. Protect disturbed and cleared areas:*

After grading is completed, seed and mulch the bare areas as soon as possible. The mulch will protect the soil until the vegetation is established. Grasses provide the best short-term protection. Blankets and matting will reduce erosion on slopes. After construction is complete, grasses can be replaced with desired long-term vegetation.

### *4. Infiltrate runoff from impervious surfaces:*

On undisturbed land much of the rainwater and snowmelt seeps into the ground. Runoff from impervious surfaces such as roofs, paved walkways and driveways, and packed soil surfaces greatly increases erosion potential. Locate infiltration trenches below roof eaves and along driveways and parking areas. If a roof drip line or driveway is on a steep slope, install a lined ditch to route the runoff to a dry well or an infiltration trench located along a slope contour.

### *5. Minimize the length and steepness of slopes:*

Long or steep exposed slopes (or roadways) have high erosion potential due to the concentration of runoff. To shorten runoff pathways, construct barriers to divert runoff before it can reach erosive velocities.

**6. Keep runoff velocities low:**

The energy of flowing water dramatically increases as velocity or volume increases. If velocity doubles, the erosive energy quadruples, and the water can move particles 64 times as large. Velocities can be kept low by:

- keeping flow volumes low (through measures such as preserving site vegetation, infiltrating runoff, or dividing runoff into several channels).
- constructing flow barriers at frequent intervals, or
- lining channels with rough materials such as vegetation or rocks.

**7. Protect drainageways and outlets from increased flows:**

Grading may cause runoff to concentrate in a single channel instead of being dispersed over a broad area. These changes can cause channel erosion unless protection measures are installed (see Sediment and Runoff Control BMP section of this booklet).

**8. Keep clean water clean:**

Divert runoff from off-site and on-site undisturbed areas away from cleared or disturbed areas.

**8. Trap sediment on site:**

Some erosion during construction is unavoidable. Sediment-laden runoff must be detained on-site so that the soil particles can settle out before the runoff reaches a stream, lake, wetland, or someone else's property. Use a combination of the BMPs outlined in this publication to keep sediment from leaving your site.

**2 — PLANNING AND SITE PREPARATION BMPs****Minimizing Disturbed Areas*****Description and Goal***

Only disturb, clear, or grade areas necessary for construction, as removal of native vegetation promotes erosion. Costly erosion control and revegetation can be avoided by minimizing the amount of disturbed area. Protect sensitive areas, particularly riparian areas along streams, wetlands, and steep slopes during construction.

***Installation/ Design Guidelines***

1. Designate areas of no disturbance. Clearly show these areas on the plans.
2. Fence or flag off areas of no disturbance.
3. Designate trees and shrubs that are to be preserved. Install protection fences no closer than the dripline of trees and shrubs to protect root systems.

***Special Considerations in Mountain Areas***

- It is typically more difficult and expensive to replace vegetation than to protect it because growing seasons generally become shorter as elevation increases.
- Request an on-site visit by a wetland scientist and/or an U.S. Army Corps of Engineers representative concerning wetlands protection and plan review prior to start of work.
- Request an on-site visit by a forester or arborist concerning protection of high-value trees. The Colorado State Forest Service provides this service on private land.

***Maintenance***

- Inspect buffers and protected areas regularly to insure vegetation remains undisturbed.
- Look for erosion or undercutting of vegetated areas and make repairs promptly.
- Look for increased sediment buildup in low points in areas of special vegetation.
- Redirect stormwater or install a sediment detention device if observed.
- Sediment basins and traps should be checked daily and after runoff events. Clear or repair filters and outlets as needed.

## Vegetation Buffers

### *Description and Goal*

Vegetated buffers spread and slow runoff and allow stormwater to percolate into the ground, reducing the runoff and sediment leaving a site. Maintain buffers during construction to protect riparian areas along streams, wetlands, and other sensitive areas. All local governments in Summit County require undisturbed buffers along streams and surrounding wetlands.

### *Installation/Design Guidelines*

1. Maintain and preserve riparian and naturally vegetated buffer strips along watercourses. Local regulations typically require no disturbance within a minimum of 25 feet from the edge of wetlands or the top of river or lake banks. Check regulations before beginning any work near streams, lakes, or wetlands.
2. Designate areas of no disturbance. Clearly show on the plans, and flag or fence off areas of no disturbance and construction vehicle exclusion.
3. Disperse concentrated runoff across the buffer strip to promote sheet-flow. This may require installation of measures to spread out concentrated flow.

### *Special Considerations in Mountain Areas*

- Request an on-site visit by a wetlands scientist and/or U.S. Army Corps of Engineers representative to identify wetlands and assist in planning for their protection prior to start of site planning.
- The U.S. Forest Service recommends a buffer of 50 feet plus four times the hillside percent slope between disturbances and streams or wetlands.
- Use native, flood-tolerant plants near water bodies.
- Ensure that the vegetative cover is dense enough to protect underlying soil while allowing sediment to settle. Soil coverage by vegetation or other measures should be at least 50%.
- Disturbance within the buffers may require a mitigation plan in compliance with local regulations or Section 404 of the Clean Water Act.

### *Maintenance*

- Inspect buffers and protected areas regularly to insure vegetation remains undisturbed.
- Look for erosion or undercutting of vegetated areas and make repairs promptly.
- Look for increased sediment buildup in low points. Redirect stormwater or install a sediment detention device if observed.



## Construction Scheduling and Phasing

### *Description and Goal*

Sequencing the construction project to reduce the amount and duration of soil exposed to erosion, and coordinating the installation of erosion and sediment control measures, can be the most cost effective methods of controlling erosion during construction. The removal of ground cover leaves a site vulnerable to accelerated erosion. Plan construction to limit land clearing, provide for timely installation of erosion and sedimentation controls, and restore protective cover quickly to significantly reduce the erosion potential of a site.

### *Installation/Design Guidelines*

1. Avoid grading the entire site if work can be completed in phases and stabilize disturbed areas before grading the next phase.
2. Leave adjoining areas planned for development, or to be used as borrow or disposal, undisturbed as long as possible.
3. Install erosion control measures prior to grading.
4. Monitor erosion and sediment control year-round.
5. Avoid disturbance during wet periods.
6. Incorporate existing natural areas and avoid disturbance of highly erodible areas.
7. Do not leave any area bare and exposed for extended periods. Mulch or provide temporary seeding for areas where work will not occur for over 14 days.

### *Special Considerations in Mountain Areas*

Short growing seasons limit the time when vegetation can be successfully established. Spring rain while soils are saturated from snowmelt can result in catastrophic erosion or slope failures.

## Considerations for Construction Scheduling

Construction Activity <sup>1</sup>	Schedule Considerations
<p><b>Construction access.</b> Construction entrance, construction routes, equipment parking areas.</p>	<p>First land-disturbing activity—Stabilize bare areas immediately with gravel and temporary vegetation as construction takes place.</p>
<p><b>Sediment traps and barriers.</b> Basin traps, sediment fences, and outlet protection.</p>	<p>Install principal basins after construction site is accessed. Install additional traps and barriers as needed during grading.</p>
<p><b>Runoff control.</b> Diversions, perimeter dikes, water bars, and outlet protection.</p>	<p>Install key practices after principal sediment traps and before land grading. Install additional runoff-control measures during grading.</p>
<p><b>Runoff conveyance system.</b> Stabilize streambanks, storm drains, channels, inlet and outlet protection, slope drains.</p>	<p>Where necessary, stabilize streambanks as early as possible. Install principal runoff conveyance system with runoff-control measures. Install remainder of system after grading.</p>
<p><b>Land clearing and grading.</b> Site preparation—cutting, filling and grading, sediment traps, barriers, diversions, drains, surface roughening.</p>	<p>Begin major clearing and grading after principal sediment and key runoff-control measures are installed. Clear borrow and disposal areas only as needed. Install additional control measures as grading progresses. Mark trees and buffer areas for preservation.</p>
<p><b>Surface stabilization.</b> Temporary and permanent seeding, mulching, sodding, riprap.</p>	<p>Apply temporary or permanent stabilization measures immediately on all disturbed areas where work is delayed or complete.</p>
<p><b>Building construction.</b> Buildings, utilities, paving.</p>	<p>Install necessary erosion and sedimentation control practices as work takes place.</p>
<p><b>Landscaping and final stabilization.</b> Topsoiling, trees and shrubs, permanent seeding, mulching sodding, riprap.</p>	<p>Last construction phase—stabilize all open areas, including borrows and spoil areas. Remove and stabilize all temporary control measures.</p>

<sup>1</sup>Maintenance, (1) maintenance inspections should be performed weekly, and (2) after periods of rainfall, maintenance repairs should be made immediately.

## Stormwater Diversion During Construction

### Description and Goal

Keeping water clean by directing runoff away from disturbed areas maximizes the efficiency of sediment removal practices and helps prevent water pollution during construction. Divert water around the construction areas to the greatest extent practicable.

### Installation/Design Guidelines

1. Approaches for temporarily diverting water around disturbed areas include:
  - *Diversion ditches and dikes:* Simple water diversions can be formed by creating a linear depression and/or a compacted earthen ridge (see diagram), installing continuous berms, entrenching a row of straw bales covered with geotextile or plastic, or routing water along plastic sheeting or other materials.
  - *Culverts:* Culverts, half culverts, or drainage tiles may be temporarily placed on the ground surface.
  - *Flexible pipe:* Flexible pipe is useful to transfer water down an embankment. Typically a culvert is necessary to intercept water.
2. Keep slopes of ditches and diversions to less than two percent unless they are protected with geotextile or rock. The end of a diversion is likely to erode, requiring stabilization with geotextile or rock.
3. Erosion of ditches and berms may mobilize sediment. Stabilize and revegetate ditches and berms as soon as possible.

### Special Considerations in Mountain Areas

- Rocky soils may not provide suitable materials for earthen diversions.
- Try to infiltrate runoff by flattening a portion of the diversion in areas with coarse soils.

### Maintenance

- Inspect diversions before and after storms for debris, rocks, and other weaknesses or breaches.
- Keep diversions free of debris and rocks or failure is likely.
- Repair structures as necessary to direct runoff away from disturbed areas.

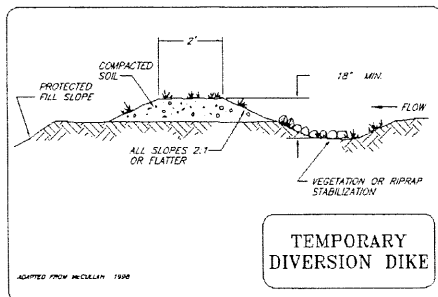

**3 — EROSION CONTROL BMPs****Land Grading For Minimizing Erosion***Description and Goal*

Disturbed land is often more than 100 times more susceptible to erosion than land with undisturbed vegetation. Soil movement is also highly dependent on the distance and slope of surfaces that stormwater moves across. Any activity that reduces the area of disturbance or the length or steepness of the slopes where runoff occurs can reduce erosion potential and the amount of sediment transported.

*Installation/ Design Guidelines*

1. Only disturb, clear, or grade areas necessary for construction. Flag, fence, or otherwise delineate areas not to be disturbed. Exclude vehicles and construction equipment from these areas to preserve natural vegetation.
2. Construct all sediment control measures before grading. Maintain measures in accordance with the approved erosion and sediment control plan and according to the standards and specifications for the appropriate erosion control practices.
3. Delineate topsoil stockpiles, borrow areas, and spoil areas on the plans and stabilize these areas to prevent erosion.
4. The outer face of any fill slopes should be allowed to stay loose, not rolled, compacted, or bladed smooth. A bulldozer may run up and down the slope so the dozer treads (cleat tracks) create grooves perpendicular to the slope.
5. Use slope breaks, such as diversions, benches, terracing, or contour furrows as appropriate, to reduce the length water runs on slopes to limit sheet and rill erosion and prevent gullies.
6. Roughen the surface of all slopes during the construction operation to retain water, increase infiltration, and facilitate vegetation establishment.
7. Stabilize all graded areas with vegetation, crushed stone, riprap, or other ground cover as soon as grading is completed or if work is interrupted for 14 working days or more. Where final grading must be delayed, use mulch to stabilize areas temporarily.

*Special Considerations in Mountain Areas*

- Slopes in excess of 2:1 may require hydroseeding, hydromulching, tactifying, netting, "punching-in" straw, bioengineering techniques, or retaining walls.
- Divert runoff from undisturbed areas away from the construction site if possible to maximize the effectiveness of sediment control measures.

## Infiltration Practices

### *Description and Goal*

Infiltration practices include measures to percolate runoff into soils. Typical practices include rock-filled trenches or basins (dry wells) and diversion of storm runoff into vegetated areas. Directing water from impervious areas and allowing it to percolate reduces the amount of sediment transported off-site. This practice can also improve compliance with local regulations, which require no increase in runoff rates as a result of development.

### *Installation/ Design Guidelines*

1. Follow design guidelines for the size and design of infiltration practices with sizing based upon the calculated infiltration.
2. Design should include a flat bottom.
3. Locate infiltration practices where there is a minimum percolation rate of 1 inch per hour and not more than 30% clay content in the soil.
4. A pre-sedimentation device, such as a grass filter strip or detention basin, is necessary for infiltration systems to avoid clogging. Installation of an observation well is recommended.
5. On slopes exceeding 10%, convey runoff to a dry well or lateral infiltration trench located along the slope contour.
6. Avoid placing infiltration trenches where their construction will damage tree roots, cause hillslope failure, damage concrete foundations, or where subsoil or bedrock conditions are not conducive to groundwater movement.

### *Special Considerations in Mountain Areas*

- Infiltration is highly dependent on subsoil permeability. Therefore, this BMP may have limited application in mountain areas with shallow soils or bedrock close to the surface.
- Do not install lateral infiltration trenches on unstable slopes or fill slopes steeper than 4:1.
- Avoid using these practices where road-sanding material is likely to reach the infiltration device.
- Locate infiltration devices 10 to 20 feet back from road subgrades, foundations, or other areas where frost heave may be a problem.

*Maintenance*

- Clean out accumulated sediment and debris before the system fails to infiltrate storm runoff. It may be necessary to replace the upper layer of stone.
- If rapid clogging occurs and pre-sedimentation BMPs cannot be placed upstream, install surface-maintained BMPs.
- Monitor observation well to evaluate whether the infiltration device is performing as designed.

## Surface Roughening and Terracing

### *Description and Goal*

Roughening or terracing a sloping bare soil surface with horizontal depressions helps control erosion by aiding in the establishment of vegetative cover with seed, reducing runoff velocity, and increasing infiltration. The depressions also trap sediment on the face of the slope. Designs of these measures vary depending on factors such as slope angle, soil type, aspect, and climate.

### *Installation/ Design Guidelines*

1. Control runoff from the site and run on from off-site flow to avoid damage and significant erosion on vulnerable or exposed slopes.
2. Surface roughen any erodible slope steeper than 3:1. Stair-step grade or terrace erodible slopes that are steeper than 2:1.
3. Break up continuous slope lengths greater than 50 linear feet by installing water bars, terraces, trenches, etc.
4. When surface roughening, groove slopes using machinery to create a series of ridges and depressions that run across the slope, on the contour. Operate tracked machinery up and down the slope to leave horizontal depressions in the soil. Do not back-blade during the final grading operation.
5. Apply seed, fertilizer, and straw mulch, then track or punch in mulch with bulldozer tracks.
6. When stair step grading or terracing, make the vertical cut distance less than the horizontal distance, and slightly slope the horizontal portion of the "step" in toward the vertical wall.

### *Special Considerations in Mountain Areas*

- Stabilize slopes prior to the first winter season, when erosion is most severe.
- Use stair-step grading or terracing on any erodible material soft enough to be ripped with a bulldozer.
- Vegetation on slopes may take several seasons to become densely established and will likely require matting, erosion blankets or other protective measures to become effective (see Revegetation BMP).
- Install subsurface drainage systems where cuts or excavations intercept groundwater.
- Do not commingle this water with stormwater if possible.

*Maintenance*

- Periodically check the seeded slopes for rills and gullies. Fill these areas slightly above the original grade, then reseed and mulch as soon as possible.
- Inspect and repair slope stabilization features as needed, especially after spring snowmelt and major storms.
- Failures generally indicate that the selected method is inadequate. Install a more protective method, rather than repairing, rebuilding, or reapplying the same BMP.

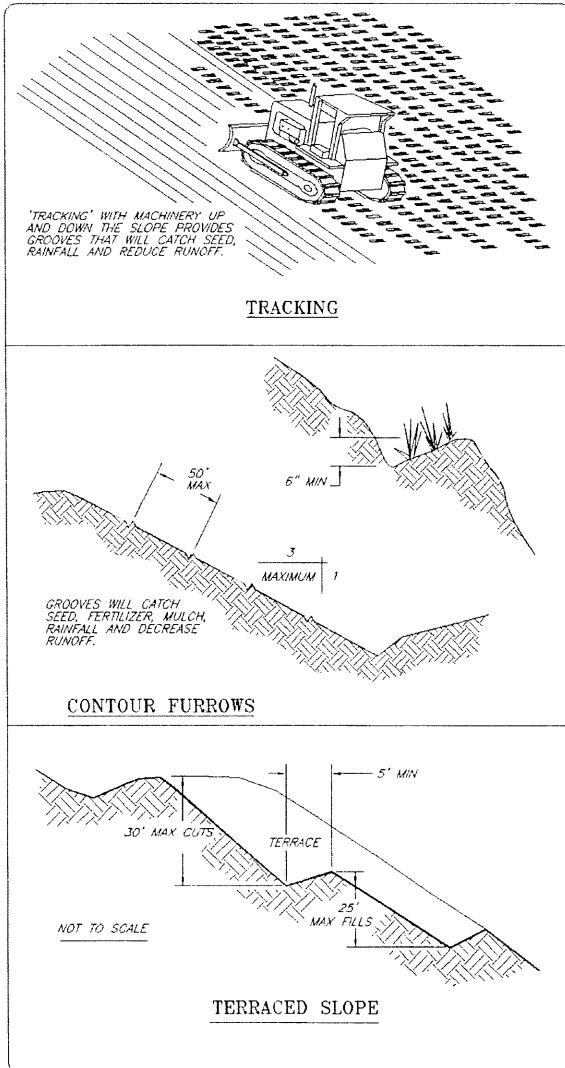



## Revegetation

### *Description and Goal*

Revegetation is the establishment of vegetative cover on soil left bare by construction or land-disturbing activities. Vegetative measures include seeding, sodding, and/or planting trees and bushes. Revegetation is the most practical approach to reducing erosion, and if done properly, provides the additional benefit of preventing weed infestation.

### *Installation/Design Guidelines*

1. Strip and stockpile topsoil during grading.
2. Install needed erosion control practices, such as sediment basins, diversion dikes, and channels prior to seeding. Divert concentrated flows away from seeded areas.
3. Soil management may be necessary to adjust the nutrient and pH content of soil. CSU Cooperative Extension can process spoil samples, and provide information regarding the appropriate soil amendments.
4. The proper seed mix and time to seed is dependent upon the climate of the area. Seed specifications are available from Summit County Government or from a professional landscaping firm.
5. Seed-to-soil contact is the key to successful germination. The seedbed should be firm but not compact. Where the area is compacted, crusted, or hardened, the soil should be loosened prior to seeding.
6. Straw mulch, erosion control blankets, or mulch and tackifiers/soil binders should be applied over the seeded areas. Always apply seed before applying mulch.

### *Special Considerations in Mountain Areas*

- Timing of planting, soil type, fertilization requirements, and irrigation availability are all serious considerations for successful revegetation.
- Select seed mixes appropriate to site conditions and the surrounding environment.
- The Summit County Government and Town of Breckenridge have recommendations for native seed mixes (see Appendix 2). Consult the CSU Cooperative Extension, The Natural Resource Conservation Service, a local agronomist, or an erosion control specialist.
- The Summit County Development code requires that sites be free of noxious weeds.
- Steeper slopes are prone to vegetation failure. Use mulch or matting on slopes steeper than 3:1.
- Seeding can occur throughout the summer in Summit County, but high soil moisture in spring and late fall provides the best germination success. Use a seed blend to include annuals, perennials, and legumes.
- Irrigation may be necessary to establish vegetation. Both temporary and permanent irrigation should be considered on some sites.

*Maintenance*

- Newly seeded areas need to be inspected frequently. Reseed areas where coverage is incomplete. Vegetation is considered established when ground cover which is sufficient to control soil erosion, survive severe weather conditions, and preclude noxious weed establishment is achieved (more than 70 percent coverage).
- Irrigation may be necessary during the first year after revegetation.
- If the seeded area is damaged, additional practices may be needed to protect the seeded area and allow for the vegetation to take hold.

## Surface Mulching

### *Description and Goal*

Mulching is the application of plant residue or other suitable biodegradable material to the soil surface. The goal of this BMP is to protect the soil surface, reducing erosion and increasing infiltration. Mulch also facilitates the growth of vegetation by increasing available moisture and insulating seeds and seedlings against extreme climate conditions. Popular mulches include straw, wood chips, and hydraulically applied products. Gravel can also be used in critical areas where permanent stabilization by vegetation is not practical.

### *Installation/ Design Guidelines*

1. Install any needed erosion and sediment control practices such as diversions, grade stabilization structures, berms, dikes, grass-lined channels, and sediment basins prior to mulching.
2. Straw mulch can be applied by hand on small sites and blown on by machine on large sites. Obtain certified “*weed-free*” straw in order to prevent the spread of noxious weeds.
3. Mulch should not be applied more than 2 inches deep on seeded sites; otherwise the mulch may be too dense for sunlight and seedlings to penetrate.
4. Mulch must be anchored immediately to minimize loss by wind or water. Hydromulching is often preferable, although it requires special equipment. Straw mulch is commonly anchored by:
  - Crimping, tracking, disking, or punching into the soil:
    - On small sites, where straw has been distributed by hand, it can be anchored by hand punching it into the soil every 1-2 feet with a dull, round-nosed shovel. A sharp shovel will merely cut the straw and not anchor it.
    - Punching mulch into the soil with an anchoring tool or tracking with a bulldozer or other equipment that runs on cleated tracks are effective ways to crimp straw into the soil. Tracking equipment must operate up and down the slope so the cleat tracks are perpendicular to water flow.
  - Covering with netting:
    - Netting of biodegradable paper, plastic, or cotton can be used to cover straw mulch.
    - Minimize netting as wildlife can become entangled.
  - Hydromulching or tacking with cellulose fiber mulch, or spraying with asphaltic or organic tackifier.
5. If soil building and revegetation is desirable, it may be necessary to increase the application rate of nitrogen fertilizer to compensate for the temporary loss of available nitrogen due to the decomposition of mulch.
6. For enhanced performance, apply seed and fertilizer prior to applying mulch to assure maximum seed to-soil contact.

### *Special Considerations in Mountain Areas*

- Mulch retains moisture, adds nutrients, and protects against climate extremes, which helps minimize irrigation requirements and improve revegetation success in mountainous areas.
- Mulch is generally ineffective on slopes steeper than 3:1. Erosion mats or other methods are more appropriate on steep slopes.
- Mulch requires crimping or tackifying to remain effective against wind or moving water common in most mountainous areas.

### *Maintenance*

- Inspect mulched areas periodically, especially after wind and rainstorms.
- Reapply additional mulch as necessary with the appropriate seed mix in bare and unproductive spots.
- Spot apply weed killers to noxious weeds.
- Mulch needs to last until vegetation develops to provide permanent, erosion-resistant cover.

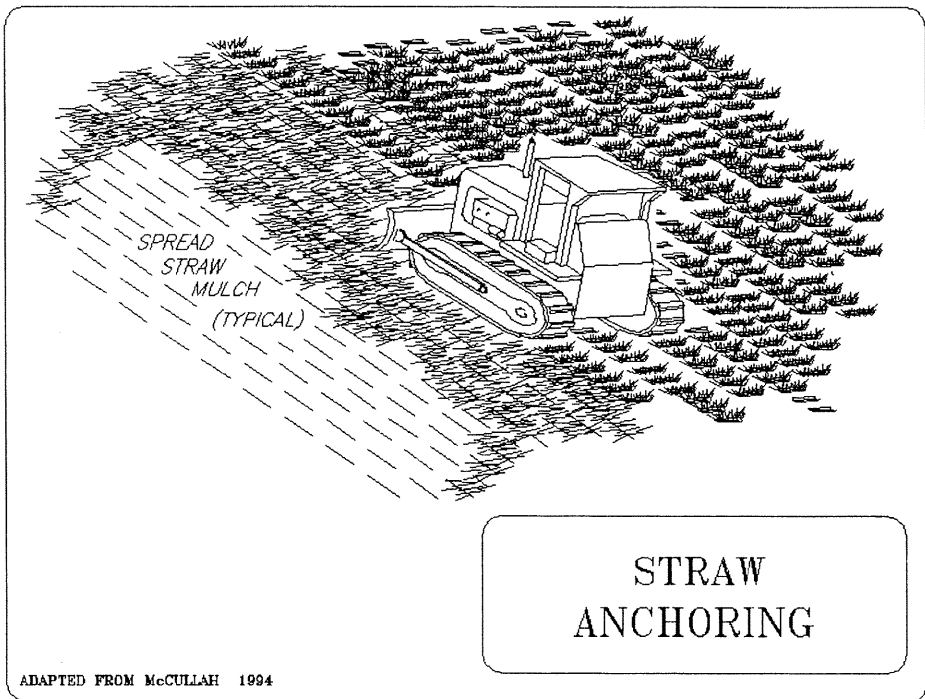

## Erosion Control Blankets

### *Description and Goal*

Erosion control blankets are strong, man-made mattings used to stabilize channels, swales, and newly planted slopes. Use erosion control blankets instead of mulch on areas of high velocity runoff and/or steep grade to aid in vegetation establishment. Erosion control blankets are suitable for steep slopes, stream banks, channels, and locations where vegetation will be slow to establish.

### *Installation/Design Guidelines*

1. Use erosion control blankets where vegetation is likely to grow too slowly to provide adequate cover, in areas susceptible to rilling, and in other areas where mulch will not hold up to concentrated flows.
2. Smooth the ground and remove any material larger than three inches in diameter prior to application.
3. Fertilize and seed in accordance with seeding specifications prior to blanket installation.
4. Install blankets parallel to the direction of the slope or flow and overlap uphill sections over downhill sections. Place erosion control blankets loosely on soil; do not stretch them or allow pockets to form between the soil and the blanket.
5. Make sure all blankets are in uniform contact with the soil. Follow manufacturer's recommendations for securing and stapling blankets in place. Ensure that all overlapped sections are secure and staples are flush with the ground.
6. Anchor the blanket at the top of the slope by trenching, stapling, and burying the blanket (see diagram).
7. Staple the blanket at least every three feet. Staple and bury blanket edges.

### *Special Considerations in Mountainous Areas*

- Use erosion control blankets to stabilize steep slopes, particularly where vegetation is difficult to establish or winds will remove mulch.
- Apply erosion control blankets prior to the first winter season, when erosion potential is greatest.
- Irrigate blanketed areas by sprinkler during the first season to promote revegetation. **Do not over-water slopes** where slippage may occur.
- Erosion may occur on slopes beneath the blankets if they are not properly installed.

### *Maintenance*

- Check for erosion and undermining periodically, particularly after storms, and monitor until permanent vegetation is established
- Repair dislocations or failures immediately.
- If washouts occur, reinstall erosion control blankets after repairing slope damage and reseeded.

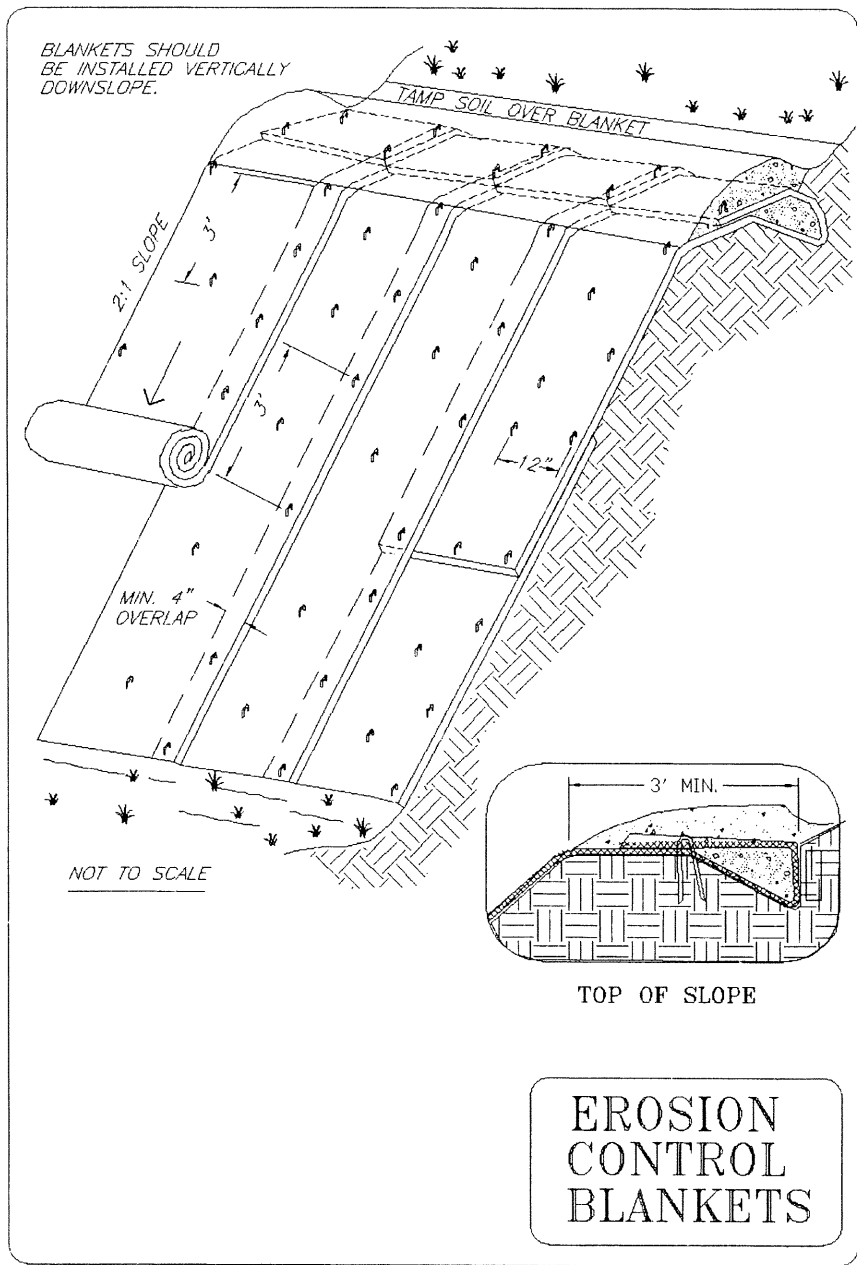

**4 — SEDIMENT AND RUNOFF CONTROL BMPs****Vehicle Tracking Controls*****Description and Goal***

Temporary construction accesses onto adjoining roads can be a source of sediment due to vehicle tracking and runoff. Vehicle tracking controls stabilize construction entrance/exits, typically using a rock bed separating construction areas from public roads.

***Installation/ Design Guidelines***

1. The width of the pad should not be less than the full width of all points of ingress or egress and not less than 12 feet wide. Fencing or other methods are often necessary to constrain traffic from unprotected points of egress.
2. Rock pads used at construction access point should be 6 inches thick.
3. The length of the pad should be as required, but not less than 50 feet.
4. Prevent sediment from entering any storm drain, ditch, or watercourse by channeling runoff to a temporary sediment trap or other suitable outlet.
5. If the grade along the pad exceeds 2% (see diagram), create a ridge in the pad parallel to the roadway.
6. If a rock pad alone is insufficient, rinse tires and wheel wells prior to entering the roadway, or use pavement.

***Special Considerations in Mountain Areas***

- Use geotextile fabrics beneath gravel to improve stability of the foundation in fine soils or locations that are frequently saturated.
- Scheduling delivery of road base for drives and parking lots early during construction may substantially reduce sediment tracked by vehicles.

***Maintenance***

- Immediately remove all sediment spilled, dropped, washed, or tracked onto public rights-of-way. Properly dispose of collected sediment.
- Inspect and maintain the gravel pad on a weekly basis to prevent mud or sediment from leaving the construction site.
- Add rock as conditions demand, and repair any measures used to trap sediment.
- After each rainfall, inspect any structure used to trap sediment and clean it out as necessary.

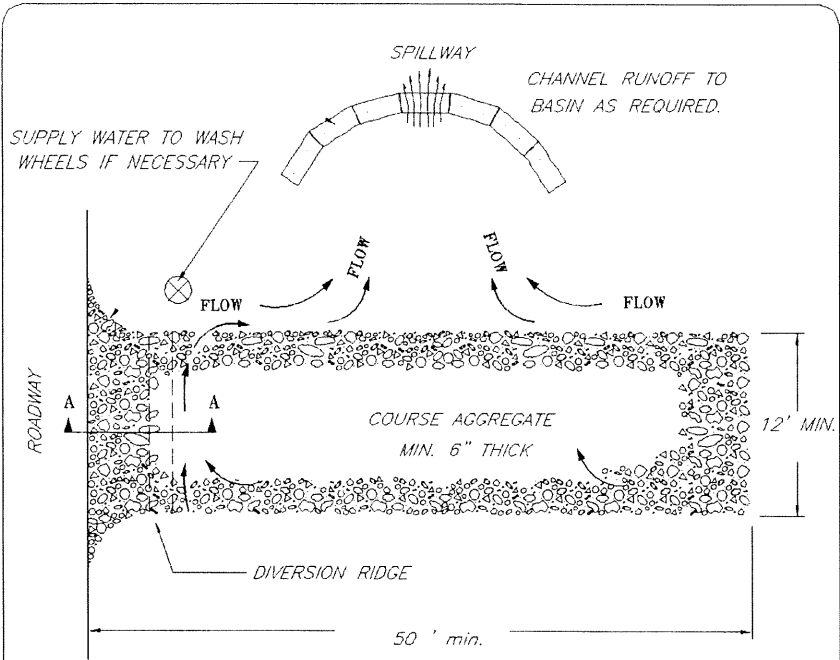

PLAN

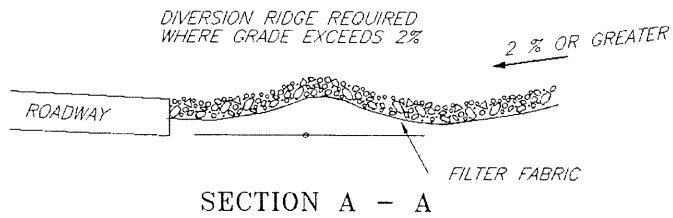

TEMPORARY  
GRAVEL  
CONSTRUCTION  
ENTRANCE/EXIT



## Sediment Traps

### *Description and Goal*

Sediment traps are temporary excavated basins or embankments that allow water to pool long enough for sediment to settle. The goal of sediment traps is to capture sediment from limited runoff areas. Sediment traps can often be converted into permanent stormwater management structures.

### *Installation/ Design Guidelines*

1. Locate traps at points of discharge from disturbed areas prior to site grading.
2. Install either by excavating below grade or building an embankment across a swale. Excavated traps are less prone to failure (see diagram). **Never construct on a live or intermittent stream.**
3. Oblong and shallow traps, with a length to width ratio greater than 2:1, are most efficient.
4. Outlet structures should consist of a combination of coarse aggregate and riprap of 6 to 10-inch size underlain with filter fabric.
5. Size the outlet crest to carry all expected flows without spilling over onto the embankment. Keep the weir at least four feet long with a minimum freeboard of 0.5 feet and sized to pass the peak discharge of the 10-year storm (Table 1)
6. Size sediment traps to hold at least 1/4 inch of erosion from contributing disturbed areas (900 -1800 cubic feet of storage per acre)
7. Avoid embankments consisting of silt, clay, or large cobbly soil as these typically fail if not protected with plastic or filter fabric.
8. Install a stick or post to indicate when the trap is full.

### *Special Considerations in Mountain Areas*

- Sediment traps are easily adaptable to many conditions, including thin soils and steep slopes. The size and shape of sediment traps can vary, making this BMP very flexible.
- Consider the volume of water and potential for impacts downhill if the embankment should fail.
- Place the traps where they are most effective, such as before pipes, in areas where slopes flatten, and where access is easy for maintenance.
- Often, the most economical sediment control measure is excavation and installation of permanent stormwater detention basins during initial grading. Collected sediments may need to be removed after site is stabilized to achieve design capacity for stormwater detention.

### *Maintenance*

- Inspect sediment traps after storms and clean them out once the trap is half full of sediment.

- Check for evidence of water moving around or under the embankment and repair embankments as needed.
- Check and remove debris from outlets.
- Dispose of the collected sediment in a stable location where it will not be reintroduced to the system.

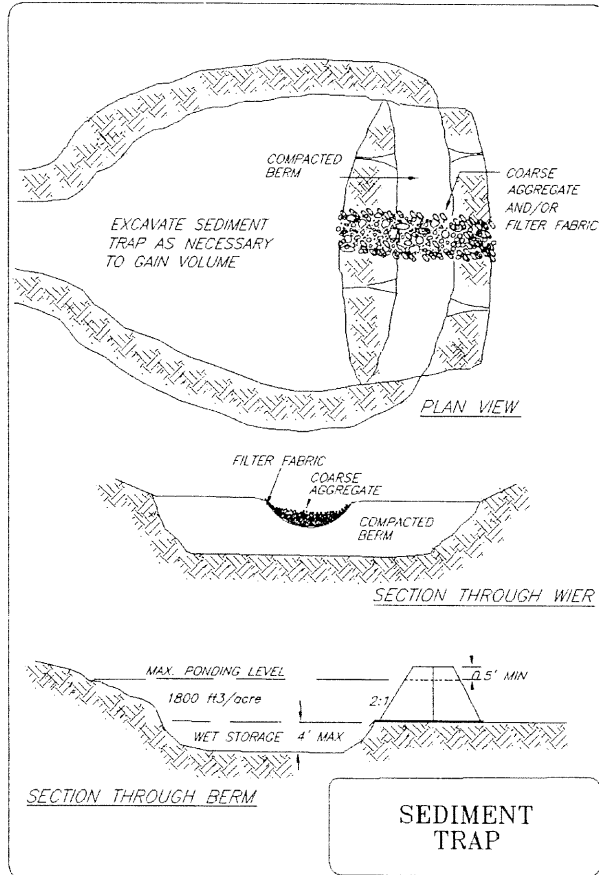

Table 1: Design of spillways for temporary sediment traps

Drainage Area (acres)	Minimum Weir Length (feet)
1	4.0
2	6.0
3	8.0
4	10.0
5	12.0

## Check Dams

### *Description and Goal*

Check dams are often constructed across drainage ditches or swales to decrease the velocity of concentrated flow. The goal of check dams is to reduce erosion and gullying in the channel and pool water long enough for sediment to settle.

### *Installation/Design Guidelines*

1. Install check dams in swales or in ditches as temporary sediment control measures or where adequate vegetation cannot be established.
2. Check dams can be built from mixed stone and gravel, logs, or sandbags.
3. The maximum height of the check dam at the center should not exceed two feet. The center of the check dam should be at least six inches lower than the outer edges.
4. Ensure that the drainage area above the check dam does not exceed two acres.
5. The maximum spacing between dams should place the toe of the upstream dam at the same elevation as the crest of the next dam downstream (see diagram).
6. **Do not place check dams in live or intermittent streams.**

### *Special Considerations in Mountain Areas*

- This BMP is appropriate where thin soils or shallow bedrock exist.
- Check dams can be used where it is not possible to divert flows away from the channel or otherwise stabilize the channel
- Installation of a foundation of filter fabric below the check dam will minimize the undercutting of embankments.
- Rock or fabric lining is preferable in channels where adequate vegetation cannot be established.

### *Maintenance*

- Maintain dams on a regular basis. Check sediment levels after storms, and clean out the sediment once the trap is half full.
- Check for evidence of water moving around or under the embankment and repair embankments as needed
- Check and remove debris from around dams.
- Dispose of collected sediment in stable locations where they will not be reintroduced to the system.
- Remove temporary check dams when no longer useful. Stabilize permanent check dams with vegetation.

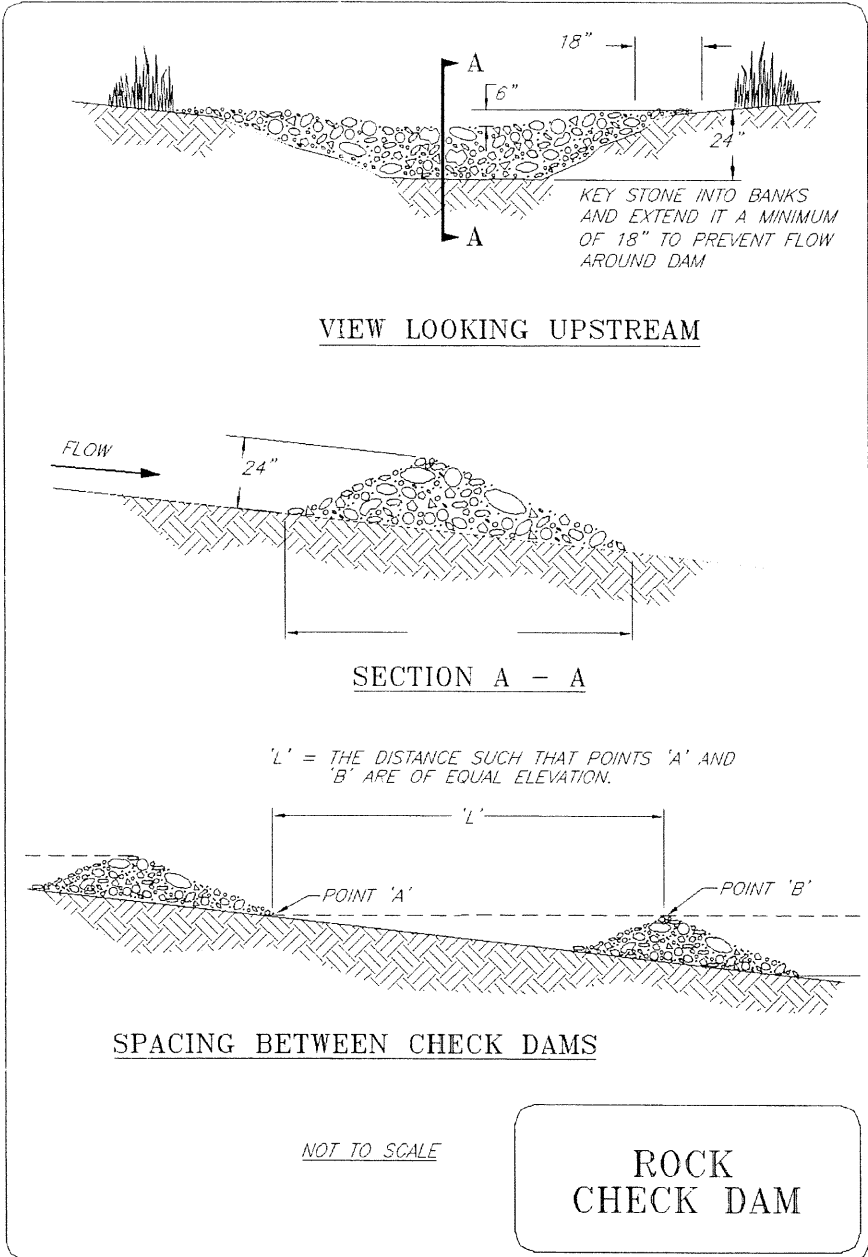

## Sediment Basins

### *Description and Goal*

Sediment basins are used to detain runoff and allow settling of sediment. Sediment basins include an outlet (usually a pipe or weir) to control the outflow rate. If properly designed and installed, sediment basins can often be utilized as stormwater detention basins after the site is stabilized.

### *Installation/Design Guidelines*

1. A sediment basin is generally the appropriate sediment management practice if more than five acres of disturbed land drains to one area.
2. The lowest portion of the site is typically the best location for a sediment basin. However, **Never install basins within wetlands or live streams.**
3. Install basins early in the construction process, allowing the BMP to be utilized for the longest period possible.
4. Divert runoff from undisturbed areas away from the construction site to maximize the effectiveness of the sediment basin.
5. Size sediment basins to provide a volume of at least 1800 ft<sup>3</sup> of volume per acre draining into the basin, or as required by local regulations.
6. Design the outlet to the basin so that it takes at least 12 hours for the basin to empty, or as required by local regulations.
7. Basins should be long and narrow (length twice as long as width) and relatively shallow in depth to provide maximum settling time.
8. Provide a stabilized outlet downstream.
9. Install an emergency spillway to protect the embankment.

### *Special Considerations in Mountain Areas*

- Thin or rocky soils may be unfavorable for building embankments. Use excavated basins or imported fill in these cases.
- Alternative inlet designs may reduce difficulties encountered with snowpack and freezing (see diagram).
- Local regulations have specific design requirements for permanent stormwater detention basins for many subdivisions and large projects. These can act as erosion control sediment basins if properly installed in the initial stages of construction.

### *Maintenance*

- Remove deposited sediment when the basin is half full.
- A sediment forebay makes clean out and maintenance easier.
- Check embankments for seepage and repair them as needed.
- Check spillways for debris and remove as necessary.
- Clean out and periodically maintain the inlet and outlet.

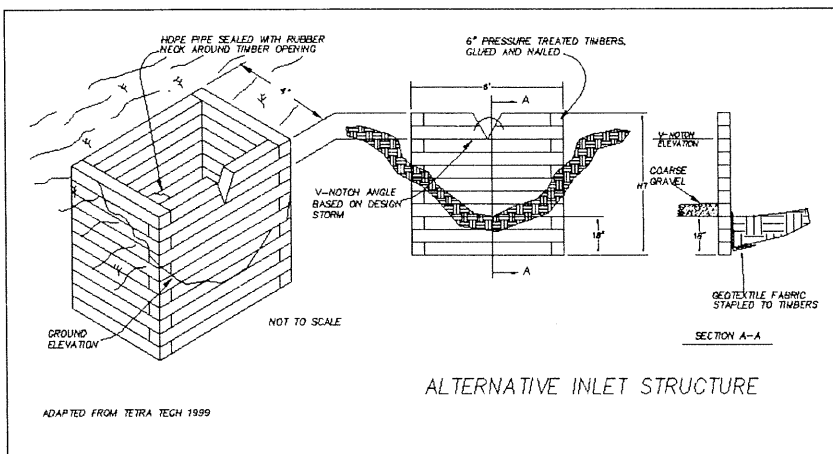
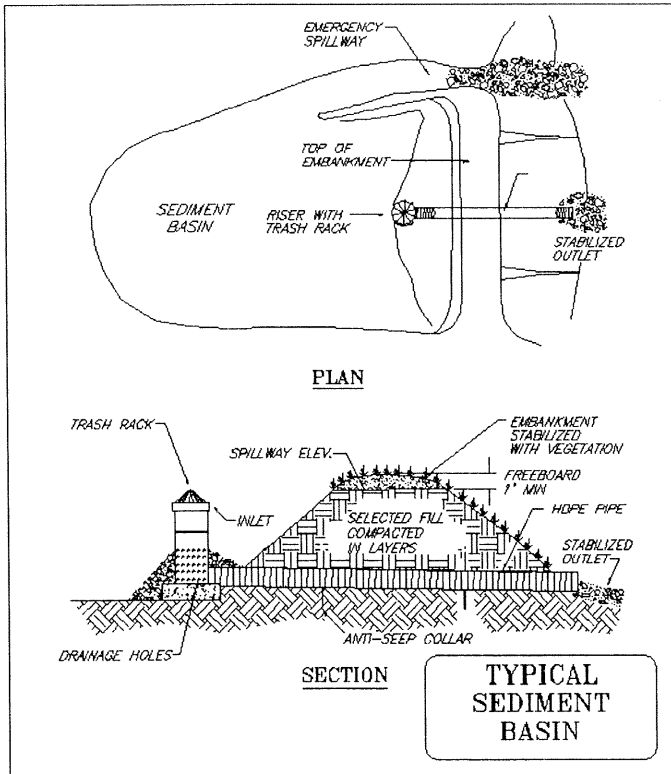

## Sandbags and Continuous Berms

### *Description and Goal*

Sandbags and continuous berms can be used in a variety of circumstances to reduce runoff velocity, pond water, or redirect flows. A continuous berm is a temporary diversion dike or sediment barrier used to divert or pond runoff and allow sediment to settle. These berms are constructed with soil, sand, or gravel encased within geosynthetic fabric and require a continuous berm machine to install. Sandbags and continuous berms generally provide superior sediment control with less maintenance than straw bales or silt fences.

### *Installation/Design Guidelines*

1. Continuous berms are useful for sediment control around the perimeter of a site.
2. Use sandbags or berms to protect drop inlets, curb inlets, or other areas that require greater strength than a silt fence (see storm drain inlet protection). Sections of continuous berms can replace sandbags or gravel for check dams and sediment traps.
3. Provide a flat or dished area in front of the barrier to allow for ponding of runoff and sediment accumulation. Excavate up-gradient if necessary to create sufficient area for sediment to settle.
4. Entrench and backfill the base of a sand bag barrier in concentrated flows in order to prevent flow under or between bags.
5. Continuous berms should form a tight seal with soil surfaces. Trenching or staking is unnecessary.
6. Performance of the continuous berm may be improved by locating a drainage chamber of coarse fill at a low spot for drainage of ponded storm water (see diagram).

### *Special Considerations in Mountain Areas*

- In thin or rocky soils, where trenching and staking is difficult, sandbags and continuous berms generally perform better than silt fences or straw bales .
- Soils with large rocks may not provide suitable fill for the berm.
- Inspect sandbags regularly. Synthetic materials used for sandbags are susceptible to ultra-violet deterioration.

### *Maintenance*

- Inspect and maintain sandbag barriers and continuous berms regularly. Promptly repair any breaks or undercutting. If undercutting is observed, compact loose soil into the area of failure.
- If vehicles run over the berm, damaged sections can be restapled or a new section can be placed in front of the damaged section. Replace broken bags immediately. Erect fencing

in front of berms used in high traffic areas in order to avoid damage to the berms by vehicles.

- Remove the berm when surfaces are stabilized by slitting the berm, spilling the fill material, incorporating it into the existing soil, and removing the fabric.
- Remove sediment behind the barrier when it accumulates six inches or 1/2 the barrier height.

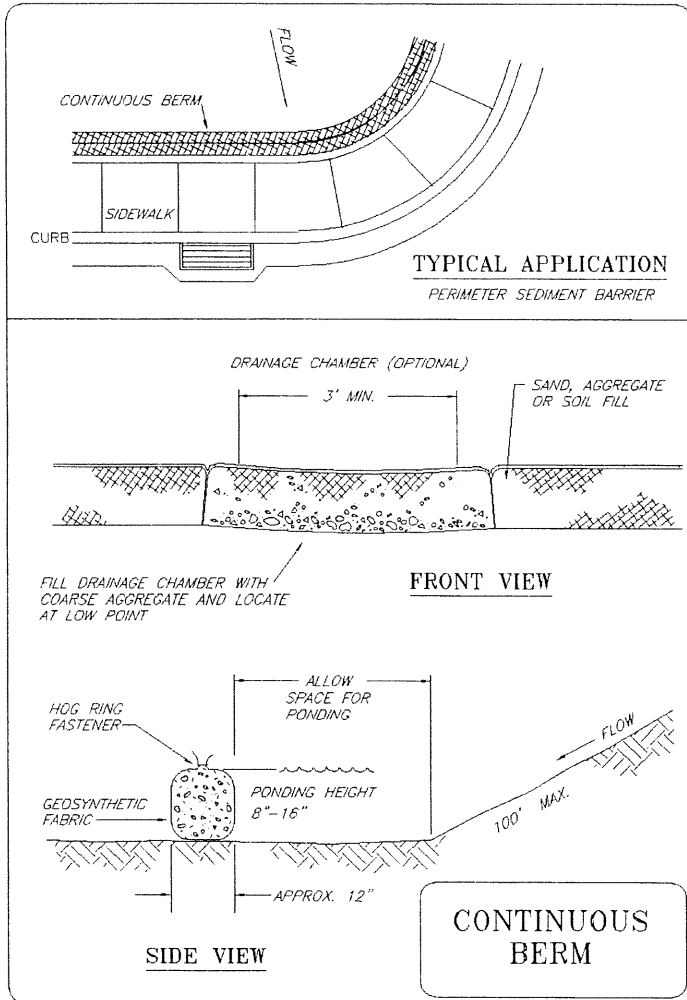



## Silt Fences

### *Description and Goal*

Silt Fences are temporary barriers constructed of woven synthetic material, buried at the bottom, stretched and supported by posts. The goal of this BMP is to reduce velocity and pool sheet flow from an eroding area, allowing the sediment to settle. Silt fences can be used along the base of slopes, around stockpiles, and in other discrete areas where erosion is likely to occur.

### *Installation/Design Guidelines*

1. Use only in areas of dispersed low-velocity runoff. Less than 1/4 acre should drain to each 100 foot of fence.
2. Anchor fences along the contour below the toe of disturbed slopes. Place fences to pond, not filter, runoff. A minimum of five feet of potential ponding area is recommended between the fence and the toe of the slope.
3. Avoid placing silt fences in ditches, except where erosion potential is low.
4. To properly install a silt fence:
  - Excavate a trench at least six inches deep, the length of the proposed barrier.
  - Place the bottom six inches to one foot of the fence material into the trench (see diagram).
  - Drive posts at least 12 inches into the ground at intervals of 10 feet or less on the down gradient side of the trench.
  - Backfill and compact soil over the fence material in the trench.
  - Secure the fence to the posts.
5. Minimize the number of joints between fences and overlap joints where they are unavoidable.
6. Silt fences should remain in place until vegetation has been established.

### *Special Considerations in Mountain Areas*

- Thin, rocky soils may preclude the use of this BMP.
- Sediment traps, check dams, or berms are often better alternatives in rocky soils, especially where depth to bedrock is shallow.
- Wire mesh and steel posts are recommended to reinforce the fence where rockfalls may occur, where grading may place soils against fence, or near environmentally sensitive areas.
- Leave enough area up gradient of the fence for runoff to pond and sediment to settle. Excavating up gradient of fence may be necessary to pond sufficient water to cause sediment deposition.
- Silt fences often must be installed several times during construction due to changing slopes and hydrology of the site.

**Maintenance**

- Check fences weekly and after rain or snowmelt.
- Ensure that silt fence material remains entrenched and anchored.
- Look for rills under or around fences.
- Replace torn or damaged sections of fence.
- Remove excess sediment periodically, at a minimum when sediment reaches a depth of eight inches.
- Silt fences may only detain sediment for a period of weeks or months. Remove fabric, stakes, and accumulated sediments when the area has been successfully revegetated.

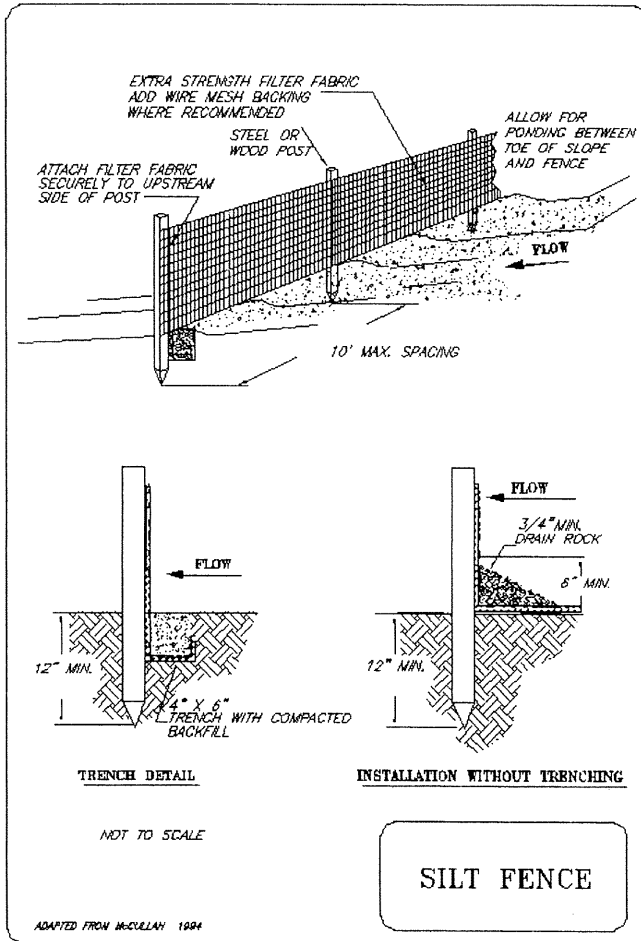

## Straw Bale Barriers

### *Description and Goal*

Straw bales can serve as a temporary sediment barrier when anchored across or at the toe of a slope to intercept surface flows from small drainage areas. The goal of this BMP is to detain runoff from a discrete, erosion-prone area long enough for sediment to settle. However, The use of straw bales is discouraged because of common failures.

### *Installation/ Design Guidelines*

1. Use only in areas of low-velocity runoff.
2. Anchor bales at the toe of slopes or in ditches where erosion potential is low.
3. Use certified “weed free” straw bales, not hay bales.
4. To properly install straw bale barriers:
  - Excavate a trench at least six inches deep, the width of the bale and length of the proposed barrier (see diagram).
  - Place the bales in the trench.
  - Stake the bales into the trench, driving the stakes six inches into the ground toward the previously laid bale to force the bales together.
  - Backfill and compact the soil against the up-gradient side of the bales.
  - Chink between bales with loose straw.

### *Special Considerations in Mountain Areas*

- Thin, rocky soils may preclude the use of wooden stakes. If metal rods are substituted, the exposed ends should have protective covering.
- Sediment traps, check dams, or berms are better alternatives in rocky soils, especially where depth to bedrock is shallow.
- Leave enough area above the straw bales for runoff to pond and sediment to settle. Excavating up-gradient of bales may be necessary to provide sufficient area for sediment deposition.
- Improved performance can be achieved by installing silt fence on the up-slope side and placing it over the bales.

### *Maintenance*

- Check straw bales weekly and after storms. Look for rills under or around bales. Fill gaps between bales and retrench bales or backfill where water is seeping underneath.
- Remove excess sediment periodically, at a minimum when sediment reaches half of the straw bale height.
- Bales may only detain sediment for a period of weeks or months. Remove bales and accumulated sediments when vegetation is reestablished.

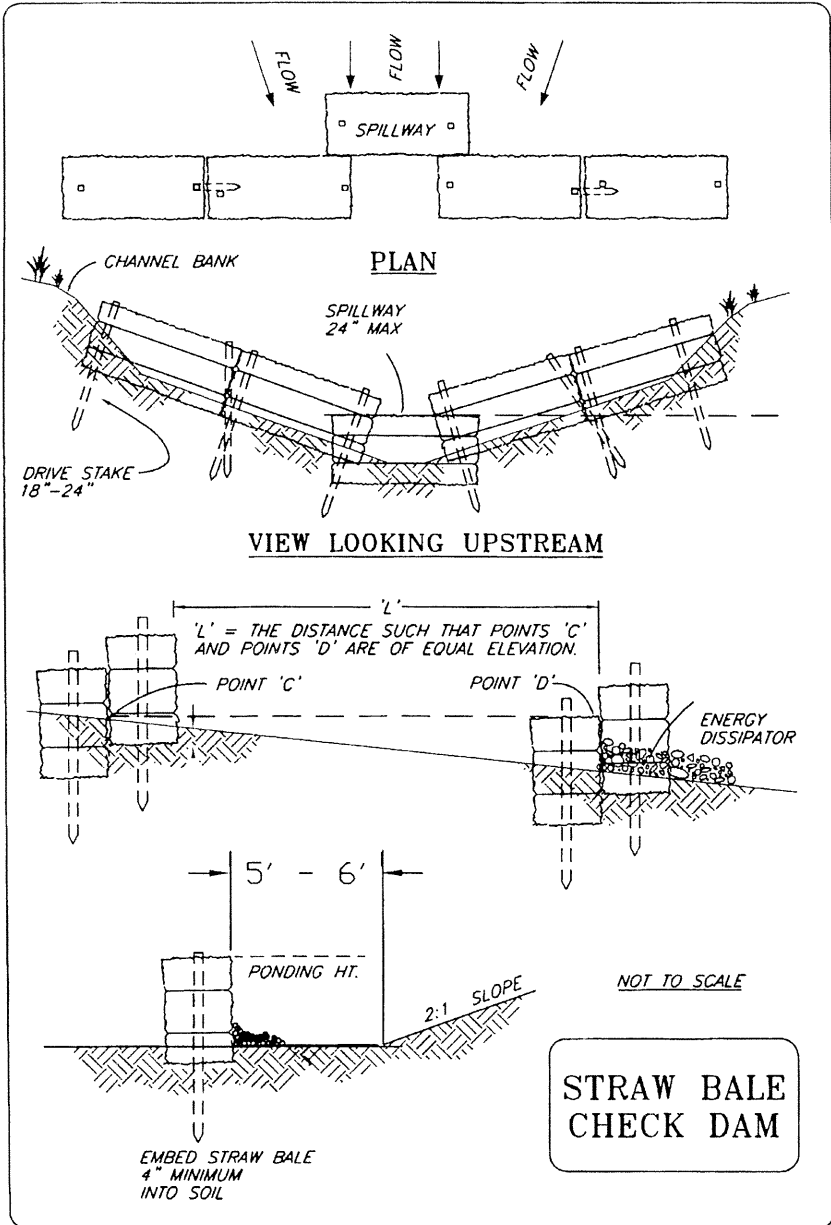

## Channel Stabilization (or Channel Lining)

### *Description and Goal*

Newly constructed channels often require lining to prevent gully erosion and the transport of excessive sediment downstream. Ideally, design channels so that their slope and cross-section force flow to be slow and shallow, thereby facilitating sedimentation and infiltration of water while limiting erosion.

### *Installation/ Design Guidelines*

1. Design constructed channels to convey concentrated surface runoff to a receiving channel without damage from erosion. Design the channel cross-section and channel lining according to the volume and velocity of expected flows.
2. Materials for rigid linings include concrete, stone masonry, soil cement or grouted rock, and are used where channel slopes exceed about five percent.
3. Typical materials for flexible linings include vegetation, erosion control blankets, gravel, or rock. Design velocities exceeding two feet per second generally require temporary liners to protect seed and soil until vegetation becomes established. Velocities exceeding four feet per second generally require permanent erosion control blankets or riprap.
4. Check dams may be installed in the channel perpendicular to the flow to slow it down and encourage settling and infiltration.
5. Vegetated swales require wide cross-sections and low-pitched side-slopes to collect and slowly convey runoff. Establishment of dense, erosion-resistant vegetation is essential for proper functioning.
6. When using rock as a channel liner, install a granular or geotextile filter prior to placing the rock. If fabric is used, place the filter fabric directly on the prepared foundation and bury the upper and lower ends of the cloth a minimum of 12 inches below ground. Take care not to damage the cloth when placing the riprap. Place rock so it forms a dense, uniform, well-graded mass with few voids. Hand placement may be necessary to obtain good size distribution.
7. Grass-lined channels with riprap bottoms must have a smooth transition and good contact between riprap and vegetation.
8. Stabilize the outlets where ditches meet receiving channels.
9. Avoid sharp changes in direction or grade, as increased erosion will occur at these locations.

### *Special Considerations in Mountain Areas*

- Stable vegetative lining may be difficult to establish and maintain in arid and cold areas. Vegetated swales are not appropriate for steep slopes (more than two percent) or high flows without protective linings.

- Rock riprap can be used to stabilize ditch bottoms in place of vegetation. Initial cost, maintenance, and aesthetics should all be considered.
- Erosion matting can protect against erosion during establishment of vegetation.

**Maintenance**

- Inspect channels at regular intervals and after major storms. Give special attention to outlets and points where concentrated flow enters the channel.
- Check for sediment accumulation, piping, bank instability, and scour holes.
- Repair eroded areas and remove sediment deposits promptly.
- Remove all unsuitable material such as trees, brush, roots, or other obstructions.
- In vegetated channels, the vegetation must be kept in healthy condition at all times to protect the channel from erosion.
- Wider, flatter, and shallower ditches are generally easier to maintain.
- Maintain centerline ditch grade according to road standards, usually between one and two feet below the edge of the roadway.

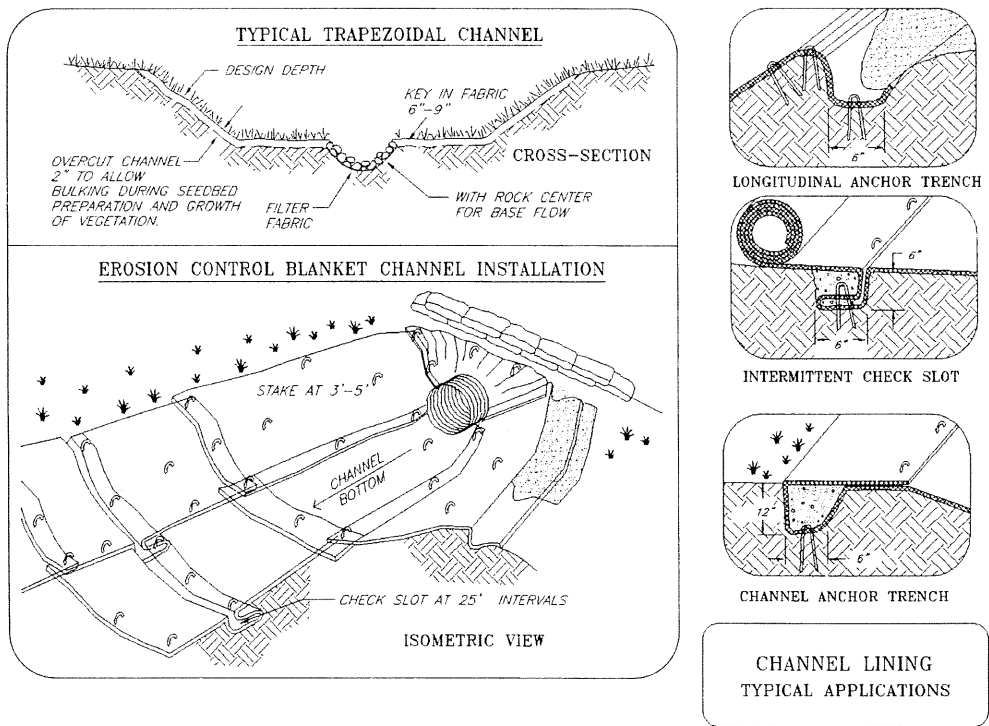

## Storm Drain Inlet Protection

### *Description and Goal*

Inlet protection consists of sediment traps around storm drain drop inlets or curb inlets. The goal of this BMP is to prevent sediment from entering storm drainage during construction. There are many designs for inlet protection and often innovation is needed to address each specific situation.

### *Installation/ Design Guidelines*

1. All storm sewer inlets that are operable prior to stabilization of disturbed areas must be protected to prevent untreated sediment-laden runoff from entering.
2. A wide variety of materials can be used to construct inlet protection, including wire screen with gravel, straw bales, silt fence, sandbags, excavated materials, or combinations of these.
3. Construct barriers to allow water to pond and sediment to settle without diverting flows away from storm drains.
4. The area around or in front of the storm inlet protection should be relatively flat or excavated to provide for sediment deposition.
5. Design barriers to allow for overflow into inlet during severe storms.
6. Commercial storm drain inlet protection devices, such as the Silt-Saver, are available.

### *Special Considerations in Mountain Areas*

- Consider the potential for damage to adjacent areas or interference with traffic if water ponds or inlets are bypassed.
- Mark inlets with stakes or poles so they can be cleaned during winter if necessary.

### *Maintenance*

- Inspect storm drain inlet protection structures periodically and after each storm. Repair when necessary, and remove accumulated sediment promptly.
- Sediment and debris must be removed from travel-ways immediately.
- Remove inlet protection structures after they have served their useful purpose. If sediment and debris enter stormsewers it may be necessary to clean stormsewer pipes.

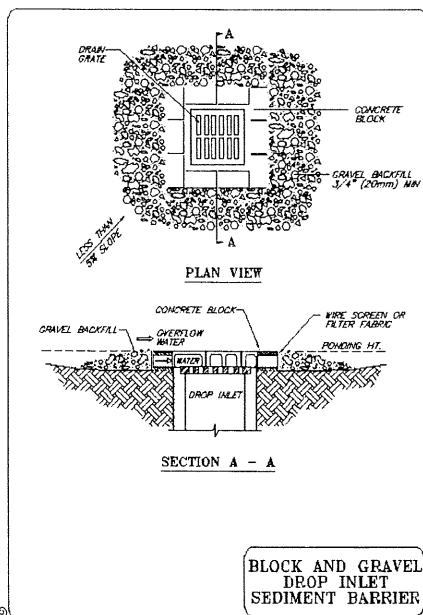
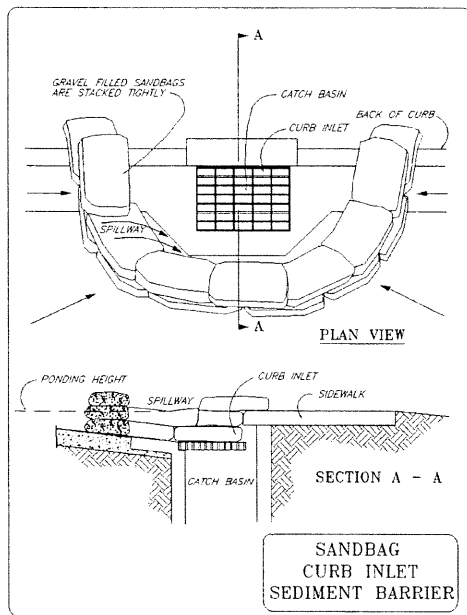
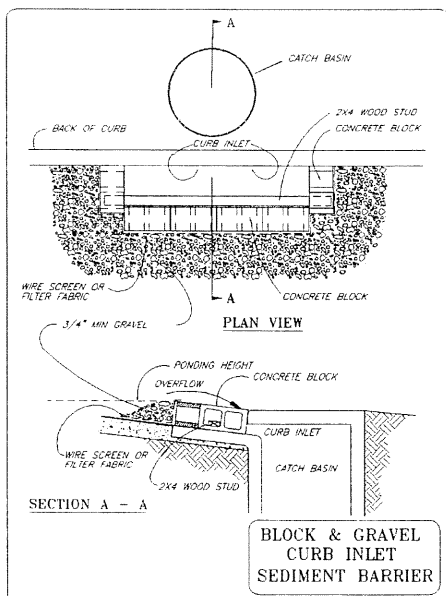
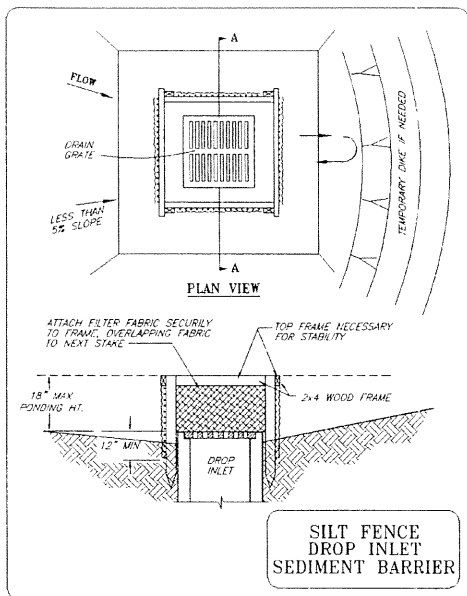



## Outlet Protection (Energy Dissipators)

### *Description and Goal*

The installation of stabilized channel sections and/or stilling basins below storm drain outlets reduces scouring and sediment transport. Outlet protection may also protect receiving channels by reducing flow velocities.

### *Installation/Design Guidelines*

1. The “apron” below the outlet may be lined with rock, concrete, or asphalt. Always place a geotextile or granular filter between the apron and the underlying soil.
2. The thickness of riprap aprons should be at least 1.5 times the maximum stone diameter.
3. Ensure that the apron is properly aligned, preferably straight throughout its length. The grade of the outlet or apron should be zero percent. Make the downstream end level with the receiving area or slightly below it.

### *Special Considerations in Mountain Areas*

- Installing a pit upstream of the inlet to catch sediment prior to entering the culvert may reduce maintenance of the outlet protection practice.
- Follow all local regulations for culverts and collars near roadways.

### *Maintenance*

- Inspect outlet structures after high flows for erosion around or below the apron, and for stones that have been dislodged.
- Immediately make all needed repairs to prevent further damage.

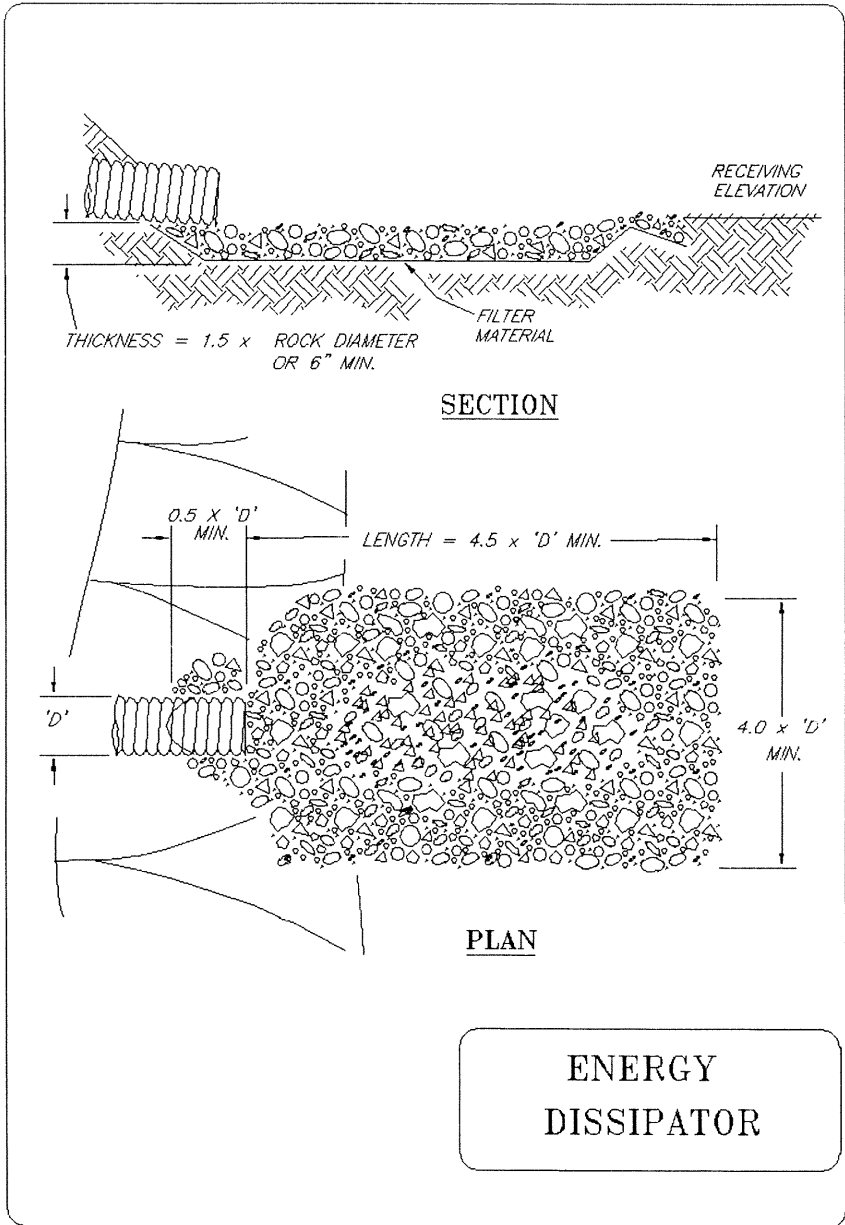

## Road and Trail Drainage

### *Description and Goal*

Proper control of road, driveway, and trail drainage is often the most important BMP for minimizing aquatic impacts of erosion and sedimentation in mountainous areas. A variety of approaches can be used, including controlling road slopes and installing waterbars, rolling dips, check dams, culverts, and other measures. Proper road drainage design decreases future maintenance costs associated with erosion and protects aquatic resources.

### *Installation/Design Guidelines*

1. Avoid insloping road surfaces and inside ditches wherever possible. Use crowning or outloping to avoid erosive concentrated flows on unpaved driveways, trails and roads.
2. Install water diversion practices in the right-of-way as soon as it has been cleared and graded.
3. Divert water from the road surface to an area where it has the greatest potential to disperse and not directly reach streams or wetlands. Build waterbars and rolling dips at an angle of 45 to 60 degrees from the centerline (see diagram). The diversion should have a positive grade of two percent minimum.
4. Provide outlet protection on hillslopes for cross drains, culverts, and other concentrated flows.
5. Space water bars appropriately, as recommended in Table 2.
6. The distance it takes for an unrocked, unprotected running surface of a nearby road to develop a one-inch rill provides a rough measure of the appropriate spacing distance between diversions.
7. Use adequately sized culverts to carry anticipated flows during at least the 25-year storm.

Table 2: Water Bar spacing (feet) on right-of-way less than 100 feet wide

Road Slope (%)	Spacing (feet)
< 5	125
5 to 10	100
10 to 20	75
> 20	< 50

Source: North Carolina Sediment Control Practices

### Special Considerations in Mountain Areas

- Construct a rolling dip, rather than a water bar, if the road is intended for winter use or use by vehicles with low clearance.
- Identify culverts with posts so they can be cleared of ice and debris in winter.
- Excavate a pit up-gradient to settle sediment prior to entering a stormwater conveyance.

### Maintenance

- Maintain the road crown, water bars, and ditch lines to drain properly.
- Clean out culverts periodically.
- Inspect waterbars and rolling dips after heavy rainfall for erosion damage. Immediately remove sediment from the flow area.
- Check outlet areas to ensure concentrated flow has not damaged hillslope stability and make repairs as needed.

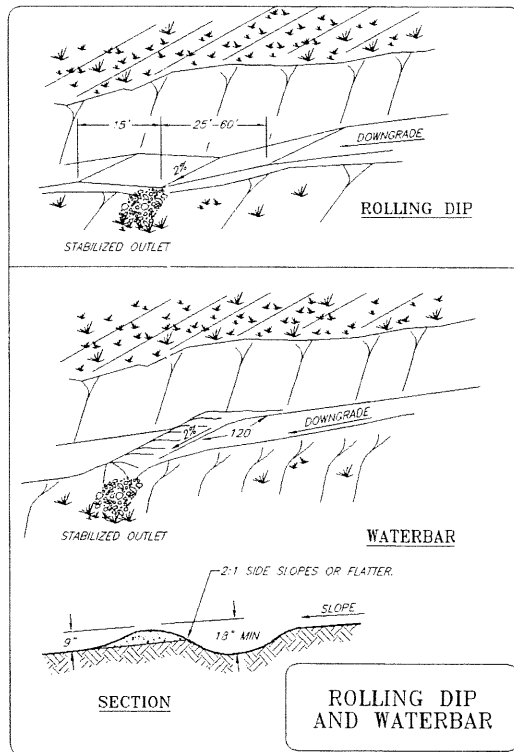

## Slope Drains

### *Description and Goal*

Slope drains are flexible or rigid conduits that extend from the top to the bottom of a disturbed or erodible slope. The goal of this BMP is to deliver concentrated runoff to a stabilized outlet, avoiding rill and gully erosion on the hillside.

### *Installation/Design Guidelines*

1. Effective slope drains can be made of open or closed pipe, strong plastic sheeting, or other heavy-duty materials designed and suitable for the purpose. Do not use perforated or slotted pipe sections in this application.
2. Fasten all drain sections securely together, use watertight fittings, and securely anchored drain sections to the slope.
3. Pipes for temporary slope drains should be larger than eight inches in diameter and be designed to carry the 10-year storm. Permanent slope drains should be designed by an engineer.
4. Compact the soil under and around the inlet.
5. Extend the drain beyond the toe of the slope and adequately protect the inlet and outlet from erosion.
6. Make the dike ridge on any supporting diversions at least one foot higher than the top of the pipe inlet.
7. If pipe is buried, install cleanouts at less than 100-foot intervals.

### *Special Considerations in Mountain Areas*

- Proper installation is very important because failure of slope drains often results in severe gully erosion or slope failure.
- A common failure of slope drains on steep slopes is caused by water saturating the soil and seeping along the pipe. Proper backfilling around and under the pipe with stable soil material and compacting small lifts to achieve firm contact between the pipe and the soil at all points will reduce potential for failure.

### *Maintenance*

- Inspect the slope drain and supporting diversions after every significant rainfall and promptly make necessary repairs. Look for rills indicating water has bypassed the inlet.
- Replace sections that are crimped or crushed.
- When the protected area has been permanently stabilized, temporary measures may be removed and materials disposed of properly. Areas disturbed in removing the structure must be stabilized appropriately.

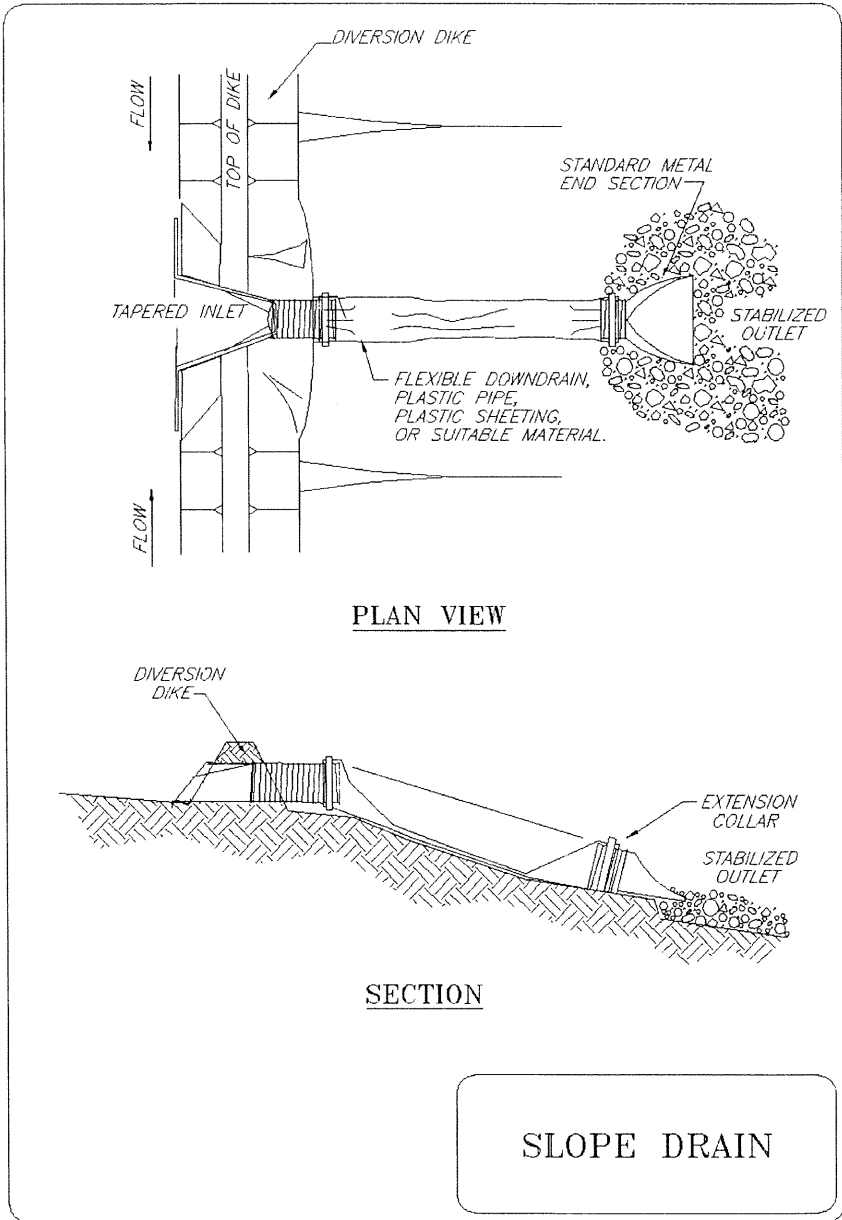

**5 — OTHER PRACTICES****Pollutant Source Controls***Description and Goal*

Pollutant source controls include construction staging, good site management, and proper storage of fuel and chemicals. Some materials used at construction sites, including fuel, lubricants, paints, solvents, concrete curing compounds, fertilizers, herbicides, and pesticides present potential for contamination of stormwater runoff. The goal of this BMP is to avoid allowing these chemicals to leave the site or reach water bodies.

*Installation/ Design Guidelines*

1. Designate an area for storage of toxic materials and petroleum products that is at least 100 feet away from storm drainage systems, riparian areas, and water bodies.
2. Know and comply with regulations governing the storage, handling, application, and disposal of toxic and hazardous materials used on site. Contact Summit County Environmental Health Department with questions about pertinent regulations.
3. Design areas used for hazardous material storage with an enclosure, container, or dike located around the perimeter of the storage area.
4. Design areas for collection and temporary storage of solid or liquid waste to prevent discharge of these materials in runoff from the construction site.
5. Use drip pans as necessary under construction equipment.

*Special Considerations in Mountain Areas*

- Construction areas in the mountains are frequently located near sensitive receiving waters. Therefore, special care is required to prevent spills from reaching these waters.
- Carefully consider and manage the use of toxic materials, such as wood preservatives, herbicides, and road surface treatments, near water bodies.
- When feasible, use non-toxic product alternatives.

*Maintenance*

- Inspect construction staging and materials storage areas on a daily basis for spills and leaks and clean up as soon as possible.

## Winter Road & Parking Maintenance

### *Description and Goal*

Although winter road maintenance, including snow removal and sanding, may be necessary for safety, plowed snow can contain residual amounts of petroleum products, salt, and sediment that can adversely impact water quality. The following guidelines will reduce adverse impacts of winter maintenance.

### *Installation/Design Guidelines*

1. Do not dump or plow snow into or adjacent to stream channels, wetlands, storm drains, or other drainageways.
2. Create a snow storage area that promotes infiltration and evaporation to prevent contaminated snowmelt from reaching stream channels.
3. Use the minimum amount of sand with the lowest possible salt content needed to enable safe use of the road or driveway.
4. Store sand and salt under cover or shelter to prevent washing away.

### *Special Considerations in Mountain Areas*

- Check local government regulations for specific requirements for snow removal and storage.
- Design sedimentation traps adjacent to driveways and parking areas to capture gravel and sand.

### *Maintenance*

- Remove accumulated sediment and debris as soon as possible. This may involve sweeping sand after storms.
- Consider reuse of captured materials.
- Repair vegetation and ditches damaged by accumulation of de-icing materials.



## ACKNOWLEDGEMENTS AND REFERENCES

The authors and Summit Water Quality Committee would like to thank the following individuals for their contributions to this manual through donation of their time and expertise.

Peggy Bailey, Tetra Tech Inc.  
 Dave Beard, Summit County Government  
 Tom Daugherty, Town of Breckenridge  
 Eric Holgerson, Town of Dillon  
 Bill Linfield, Town of Silverthorne  
 Mark Luna, Town of Frisco  
 Scott O'Brien, Town of Dillon  
 Ric Pocius, Summit County Government  
 Robert Ray, Northwest Colorado Council of Governments  
 Cover Photograph by Bob Winsett

Drawings and Tables included in this manual were adapted from figures published in the following sources:

- Erosion Draw 2.0 Software: Drawings copyrighted 1994, 1998 by John McCullah
- Wright Water Engineers Inc.: Appendix I Erosion Control Toolbox
- North Carolina Erosion and Sediment Control Planning and Design Manual: Construction Scheduling Table and Water Bar Spacing Table
- Tetra Tech Inc.: Alternative Inlet Structure

The following references provide additional guidance on appropriate BMP design:

- Colorado Department of Transportation, 1995. *Erosion and Sediment Control Pocketbook*.
- Colorado State Forest Service, 1998. *Colorado Forest Stewardship Guidelines to Protect Water Quality*.
- Denver Regional Council of Governments, 1998. *Keeping Soil on Site: Construction Management Practices*.
- Denver Regional Council of Governments, 1998. *Mountain Driveway Best Management Practices Manual*.
- North Carolina Department of Natural Resources and Community Development, 1988. *Erosion and Sediment Control Planning and Design Manual*
- Salix Applied Earthcare, 1994. *Erosion Draw 2.0 Software and Erosion and Sediment Control Manual for Computer Aided Drafting*. Drawings © 1994, 1998 by John McCullah.
- Summit Water Quality Committee, undated. *Guide to Water Quality Protection and Erosion Control*.
- Urban Drainage and Flood Control District, Denver, CO, 1992. *Urban Storm Drainage Criteria Manual, Volume 3*.

## APPENDIX 1

**Summit County Recommended Revegetation Seed Mixture**

This is a list of recommended grass species suitable for native revegetation. This recommendation encourages that whenever and wherever possible, a revegetation seed mix be comprised fully of these natives. Or, at a minimum, that some of these species be incorporated within a seed mix. Plant species are grouped in decreasing order of dominance (group 1 = highest dominance, last group = lowest dominance).

**High Elevation Native Species – 9,100 feet to ~ 10,000 feet****Group 1**

Idaho Fescue	<i>Festuca idahoensis</i>
Thurber's Fescue	<i>Festuca thurberi</i>
Arizona Fescue	<i>Festuca arizonica</i>
Alpine Fescue/Rocky Mtn. Fescue	<i>Festuca saximontana/Festuca brachyphylla</i>
Alpine Poa/Bluegrass	<i>Poa alpina</i>

**Group 2**

Canada Bluegrass	<i>Poa compressa</i>
Tufted Hairgrass	<i>Deschampsia cespitosa</i>

**Group 3**

Junegrass	<i>Koeleria macrantha</i>
Parry's Oatgrass	<i>Danthonia parryi</i>

**Group 4**

Bluebunch Wheatgrass	<i>Agropyron (Pseudoroegneria) spicata</i>
Needle-and-Thread Grass	<i>Stipa (Heterostipa) comata</i>
Ricegrass	<i>Stipa (Oryzopsis) hymenoides</i>

**Low Elevation Native Species ~ 8,000 feet to 9,100 feet****Group 1**











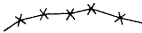

Western Wheatgrass	<i>Agropyron (Pascopyrum) smithii</i>
Bluebunch Wheatgrass	<i>Agropyron (Pseudoroegneria) spicata</i>
Needle-and-Thread Grass	<i>Stipa (Heterostipa) comata</i>
Ricegrass	<i>Stipa (Oryzopsis) hymenoides</i>
June grass	<i>Koeleria macrantha</i>
Canada Bluegrass	<i>Poa compressa</i>

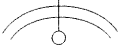
**Group 2**

Tufted Hairgrass	<i>Deschampsia cespitosa</i>
Idaho Fescue	<i>Festuca idahoensis</i>
Alpine Fescue/Rocky Mtn. Fescue	<i>Festuca saximontana/Festuca brachyphylla</i>
Thurber's Fescue	<i>Festuca thurberi</i>

## APPENDIX 2

## Erosion Control Toolbox of Best Management Practices

- VTC**  **CONSTRUCTION ENTRANCE**  
A gravel pad, located at the points of vehicular ingress and egress on a construction site, to reduce the mud transported onto roads and paved areas.
- STB**  **STRAW BALE BARRIER**  
A temporary sediment barrier composed of anchored straw bales placed across or at the toe of a slope to intercept and detain sediment and decrease flow velocities from small drainage areas; applicable where sheet and rill erosion potential is low to moderate.
- SBB**  **SANDBAG BARRIER**  
Temporary stabilization of ditches by placement of sandbags perpendicular to flow. Accompanied by a depression upstream for sediment retention. Good for use where soils are difficult to excavate, in areas of shallow bedrock, and in steep drainages.
- SF**  **SILT FENCE**  
A temporary sediment barrier constructed of posts, filter fabric and, in some cases, a wire support fence, placed across or near the toe of a slope or in a minor drainageway to intercept and detain sediment and decrease flow velocities from drainage areas of limited size; applicable where sheet and rill or small concentrated flows may be a problem.
- ST**  **SEDIMENT TRAP**  
A small ponding area, formed by constructing an earthen embankment with a gravel outlet across a drainage swale, to detain sediment-laden runoff from small disturbed areas for enough time to allow most of the sediment to settle out.
- SB**  **SEDIMENT BASIN**  
A basin with a controlled stormwater release structure, formed by constructing an embankment of compacted soil across a drainageway, to detain sediment-laden runoff from disturbed areas greater than five acres for enough time to allow most of the sediment to settle out. Can be constructed only where there is sufficient space and appropriate topography.
- BB**  **BRUSH BARRIER**  
A temporary sediment barrier composed of limbs, weeds, vines, root matter, soil, rock and other cleared materials pushed together to form a berm; located across or at the toe of a slope to intercept and detain sediment and decrease flow velocities during grading operations. Removed at the time of final grading.
- CD**  **CHECK DAM**  
Small temporary berms constructed across drainageways to reduce the velocity of concentrated flows, reducing erosion of the swale or ditch. Limited to use in small open channels which drain small areas. Should not be used in live streams.
- GS**  **GRASS LINED SWALE**  
The establishment of appropriate vegetation in constructed channels to limit channel erosion and stabilize channel bottom.
- PP**  **REVEGETATION**  
Establishment of vegetative cover by planting seed and sodding, or planting live plants to protect soil from erosion.
- TM**  **TEMPORARY MULCHING**  
Use of crimped straw, wood chips, sawdust, etc., to cover the denuded surface shortly after clearing and grubbing, and construction activities. Mulching is the most effective temporary erosion control practice.
- PP**  **PERMANENT MULCHING**  
Use of wood chips, stone, bark etc., to cover the finished graded surfaces after construction activities. Mulch within 3 days of operations to eliminate erosion and conserve moisture for plantings. Part of the final landscaping including drainageways, swales, etc.
- IP**  **INLET PROTECTION**  
The installation of various kinds of sediment trapping measures around inlets, culverts and structures prior to permanent stabilization of the disturbed area; limited to small drainage areas and not intended to control large, concentrated stormwater flows.
- DD**  **DIVERSION DIKE**  
A ridge of compacted soil to divert off-site runoff away from unprotected slopes, or to divert sediment-laden runoff to a sediment-trapping structure.

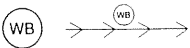

**WATER BAR**

Small berm and ditch combination laid across a slope or roadbed at 45 to 60 degrees to reduce the velocity of concentrated flows, reducing erosion. For use as a semi-permanent structure on trails, ski runs and seasonal access roads.



**GEOTEXTILE MATTING**

Strong man-made mattings used to stabilize the flow on high velocity channels and swales. Also used as a reinforcement between courses on road work over soft areas. Recommended for use in retaining wall and fill slope construction as a tie-back into native materials.

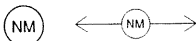

**NATURAL MATTING**

Biodegradable materials, such as straw and excelsior bound in netting and impregnated with seed, are used on slopes where rill and sheet erosion may be a problem and where seed and mulch will not be effective. Can be utilized in temporary and permanent seeding solutions as necessary.



**TEMPORARY STREAM CROSSING**

A temporary structural span across a stream to provide vehicular access to construction activity on either side of stream while keeping sediment out of the stream and preventing damage to the channel and banks. Used in conjunction with other measures to avoid sedimentation of the receiving water.

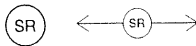

**SURFACE ROUGHENING**

Grading practices such as stair-stepping, grooving slopes or leaving slopes in a roughened condition. Reduces runoff velocity, provides sediment trapping and increases infiltration; all of which facilitate establishment of vegetation on exposed slopes.



**SLOPE DRAIN**

A flexible conduit, used before permanent drainage structures are installed; intended to convey concentrated runoff safely from the top to the bottom of a disturbed slope without causing erosion on or below the slope.



**OUTLET PROTECTION**

The installation of paved or rip-rap channel sections and/or stilling basins below storm drain outlets to reduce erosion from scouring at outlets and to reduce flow velocities before stormwater enters receiving channels below these outlets.



**RIP-RAP PROTECTION**

A permanent, erosion-resistant ground cover of large, loose, angular stone installed wherever soil conditions, water turbulence and velocity, expected vegetative cover, etc., are such that soil may erode under design flow conditions.



**CONSTRUCTION ROAD STABILIZATION**

Temporary stabilization of high traffic areas prone to erosion with stone immediately after grading to reduce erosion potential damage caused by vehicles during wet weather and to prevent having to regrade roadbeds.



**DUST CONTROL**

Reducing surface and air movement of dust during land disturbance, demolition or construction activities in areas subject to dust problems in order to prevent soil loss and reduce the presence of potentially harmful airborne substances. Includes the covering of soil stock piles and construction materials.



**TOPSOIL PROTECTION**

Stripping, stockpiling and protecting topsoil for later use in permanent landscape activities. Stockpiles are covered with sheeting, mulch and/or seed and surrounded by a containment berm to protect them from erosive forces. Periodic "turning" of the piles is required to maintain endemic microbial soil organisms.

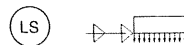

**LEVEL SPREADER**

An outlet for dikes and diversions consisting of an excavated depression constructed at near zero grade across a slope to convert concentrated runoff to sheet flow and release it onto areas of undisturbed soil stabilized by existing vegetation.



**CLEAR WATER DIVERSION**

A temporary re-routing of a watercourse through a sluice or tube to reduce the amount of clean water collecting sediments from active construction operations

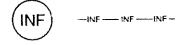

**INFILTRATION TRENCH**

A semi-permanent sub-surface drain that allows for storm water to be absorbed by the ground in a ponded area.

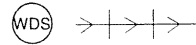

**WATERWAY DROP STRUCTURE**

A permanent structure or series of structures designed to "step" water flow down a slope without causing channel erosion; applicable in channels with long, relatively steep reaches.

*Note: Additional practices not shown here can be implemented based on field observations and adjustments for weather, season and unforeseen site conditions. Contact your local planning office for specific site recommendations and further assistance. Use these convenient symbols and descriptions when devising an erosion control plan for the intended project. The symbols are nationally accepted while the descriptions are tailored for mountain driveway construction.*



## **Summit Water Quality Committee**

Post Office Box 2308 • 249 Warren Avenue • Silverthorne, CO 80498  
(970) 468-0295 • Fax (970) 468-1208

Breckenridge • Dillon • Frisco • Montezuma • Silverthorne • Summit County  
Breckenridge Sanitation District • Copper Mountain Consolidated Metro District • Frisco Sanitation District  
Silverthorne/Dillon Joint Sewer Authority • Snake River Sewer Plant